

World Gateball Union
Guide for Referees

{ I } The role of the referee

The referee must ensure that the game is played in accordance with the rules from start to finish. He or she must also remain impartial at all times and make decisions and announcements regarding a player (stroker) based on the game rules. In the event of a violation, the referee must accurately deal with that violation and ensure that the game is fairly and quickly played out.

Although teams aim to win, winning is irrelevant to the referee, whose primary aim is to make decisions regarding moves that contravene the rules and ensure that the game proceeds and concludes without delay. But at the same time, he or she must also convey, to the team, how amazing gateball is when the rules are followed, remaining fair and smoothly making judgements to maximize both the player's skills and their focus and level of concentration during the game.

1. Referees and the game rules

The game of gateball is underpinned by the game rules. Anyone involved in the game must have a thorough understanding of, respect for, and willingness to comply with, the game rules. Following the rules represents a commitment to the game, and it is the referee who decides whether players are playing in accordance with those rules. Therefore, the referee is required to not only have a thorough knowledge and understanding of the rules, but also to ensure that all referee operations reflect these rules. However, even though a referee may recognize the importance of the game rules and deepen his/her understanding of each rule, a referee cannot do his or her job without knowing how to apply the rules. This is why the referee must have knowledge of the gestures outlined in the Guide for Referees, be able to make swift decisions, and immediately take the correct action.

2. What referees should be mindful of

(1) Making the correct decision

After a match, spectators will often discuss what took place during the match, such as how well Player xx on Team xx played, or whether xx's ball should have been stroked in a direction to Gate xx. Any mention of the referee in such discussions would often be in a negative context. Often the conversations point to a refereeing error, such as "The ball should have been made an out-ball after Number xx's foul, but the referee ruled that it should be returned to the position it stopped in after the Touch", while at other times people may even say that a team lost because of a referee. The referee should always ensure that game is conducted smoothly and in a way that is acceptable to the players of both teams and the spectators, and that the game is played out in a way that the presence of the referee at the game is barely noticed.

(2) Remaining calm

It is important that the referee always remains calm, as it is difficult to make fair and impartial decisions when one loses control. For example, the bigger the match, such as the final game of a national championship, the greater the number of spectators and the greater the possibility of live TV coverage. Naturally, this leads to higher levels of nervousness and tension among the players. This in turn results in more pressure on the referee and consequently a greater possibility of losing one's composure.

If the referee can remain calm regardless of the situation, then that referee can carry out his/her role without making any major errors. However, even referees can't always remain totally unaffected in all situations. All one can do is become accustomed to these pressures. The more experience you gain refereeing large games, the more adept you will become at remaining calm in any situation.

(3) Building a relationship of trust with the players

The referee must not forget that the players are central to the game. The referee must also control each match to ensure that each player can maximize his or her skills. In order to do this, it

is important that the referee establish a relationship of trust with the players. This can be done by communicating with players in a relaxed atmosphere at the ceremony before the start of the game. Exchanging a few words with players is effective, but it is best to avoid long conversations as these may lead to misunderstanding. In addition, the decision-making should be consistent throughout the game. Avoid situations in which others don't understand why a decision was made. If, despite this, a wrong decision is made, or there is an example of a move that makes a decision difficult, the referee should not make a decision that is ambiguous. Instead, the referee should consult with the assistant-referee (or chief referee) and recorder and make a decision based on their advice. If a mistake becomes apparent and a decision is amended, this shouldn't result in an issue as long as both teams accept the final decision (although this will depend on the situation). However, a referee insisting that his/her wrong decision is correct will only confuse the players, will prevent a relationship of trust being built, and worse still, the players will not trust that referee. And if an issue arises during a game and the referee cautions a player in an intimidating manner, that player is likely to become even more agitated, resulting in a breakdown in the relationship of trust between the referee and that player. Obviously even a referee can become a bit agitated at times. Also, at times the referee needs to be authoritative. A referee, however, should always be mindful of the importance of maintaining a sense of composure at all times. A relationship of trust will be automatically established if the referee maintains a sense of calm and composure, is uncompromising, and is polite when addressing with players.

3. In order to improve refereeing skills

(1) Learn from outstanding referees

It is recommended that referees observe outstanding referees, and identify what makes them outstanding. Also discuss, with other referees, a referee's movements, decisions and announcements, and gestures, identifying the positive aspects and applying these to your own refereeing. Strive to incorporate, on an ongoing basis, the

positive aspects of other referees into your own refereeing skills.

(2) Build your experience as a referee

Refereeing at as many matches as possible is the best way to improve your refereeing skills. Also important is to always reflect back on a match. If the referee experienced a situation for the first time in that match, he/she should recall the situation and identify whether it was addressed quickly. Reflection is the key to progress and improvement. The referee must avoid getting upset with his/her first-time experience of a violation of the rules. Even if a certain move or play makes decision-making difficult, if that referee has extensive refereeing experience, then that referee can refer to this experience to make a decision. Acquiring extensive knowledge and experience by refereeing at various games is essential to improving a referee's skills.

4. In order to be an even better referee

(1) Things to be mindful of on a daily basis

A referee should always be mindful of maintaining a physical and emotional balance in order to carry out his/her duties completely and accurately. The referee should also ensure that he/she is in the best condition in order to be able to carry out his/her refereeing skills to the best of his/her ability. Qualities demanded of a referee are focus and decision-making skills, so regular exercise like walking, jogging or stretching is recommended. Referees should also practice the referee gestures in front of a mirror, and also to initiate refereeing even during practice matches. If, for some reason the referee doesn't feel well, then he/she shouldn't accept the role of refereeing at a match; after considering the environment or season, he or she should politely decline the refereeing request. This is because even though a player can be replaced mid-game, once a referee accepts his/her role, he/she is obliged to carry out that role to the conclusion of the game.

(2) Things to be mindful of the day before a match or tournament

The referee should get plenty of rest and have a good night's sleep to ensure that he/she is in the best physical and mental condition to carry out his/her role. The referee must avoid over-indulging

in alcohol, for example, which will have a negative physical or mental effect, and consequently affect his/her decision-making skills. The referee must also confirm when the game is being played, the meeting point, and, if possible, the games that the referee will be refereeing at. The referee uniform and shoes (and if staying overnight at a venue, change of clothing and toiletries) should be prepared. Not to be forgotten is the Official Gateball Rules and Guide for Referees booklet. Although it is difficult to predict what will take place during an actual game, it is important that the referee doesn't use intuition and instead always has the Official Gateball Rules and Guide for Referees ready in order to make the correct decision. Once everything has been prepared, the referee can now relax. If anything comes to mind, then the Official Gateball Rules and Guide for Referees can be referred to. It is also recommended that the referee confirm what should be done in the event of a possible issue during the game, by once again referring to this document.

(3) Things to be mindful of on the day of the match or tournament

① Warming up

The referee will often be more active on the ground than the players. It is important, on the day and at the venue to improve one's flexibility by doing stretches or other types of light warmup exercise.

② Meetings among the referees

Short pre-game meetings are sufficient for referees who frequently work together. However, it is important to have longer a pre-game meeting for referees who will be working together for the first time. There needs to be a sufficient level of communication between the Chief Referee, Assistant Referee and Recorder because teamwork among the referees is extremely important. Decisions will not be made quickly without a sufficient level of communication, resulting in the possibility of an over-use of referee time or decision errors. Establishing teamwork among referees through a pre-match meeting, on the day, is an important element of good refereeing. It is important to deepen mutual understanding, particularly in

reference to “Basic Interaction between the Chief Referee and the Assistant Referee”, “The Recorder’s Advice to the Chief Referee and the Assistant Referee”, “Responding to the Chief Referee and Assistant Referee’s Confirmations” and “Agreed Matters during a Competition”.

③ Post-tournament (game) reflection

Once a game has concluded, the score has been confirmed and the winner announced, the referee will experience a sense of satisfaction and fulfilment when the captains of both teams sign the record sheet. What must not be forgotten, however, is for the referee to have a discussion with the other referees involved in the match about the refereeing operations, and if necessary, evaluate the decisions that were made. If the match was seen by the Chairman of the Referee Association or other referee colleagues, then the referee should actively seek their feedback and advice. Those who are in the position of giving advice should not only point out any errors or areas for improvement, but to also praise what was carried out well, and ensure that the advice given is about improving refereeing in future games. Each referee should listen to this advice calmly and with a spirit of constructive self-criticism, and be proactive in absorbing this knowledge and information. Doing so will prove invaluable in improving your refereeing skills.

〔Ⅱ〕 The Referee's Uniform and Essentials

1. The Referee's Uniform and Essentials

- (1) The referee's uniform
 - 1) A referee uniform approved by the World Gateball Union or one of its member organizations should be worn by the chief referee, assistant referee, recorder and linesman.
 - 2) No one other than the referee appointed for the match shall wear the referee uniform.
- (2) Referee shoes
 - ① Athletic shoes (white shoes preferable)
- (3) Referee's essentials
 - 1) Chief referee
 - ① Chief referee's armband
 - ② Coin for the coin toss
 - ③ Marker
 - a. A tool to mark the position of a ball that has temporarily moved.
 - ④ Measuring tool (7.5cm × 10cm)
 - a. A tool for making an accurate decision on temporarily moving a ball that could obstruct a pass through the first gate, or for making an accurate decision on a Spark.
 - 2) Assistant referee
 - ① Assistant referee armband
 - ② Marker
 - ③ Measuring tool (7.5cm × 10cm)
 - 3) Recorder
 - ① Recorder armband
 - ② Record sheet (binder) and pen
 - ③ Marker
 - ④ Measuring tool (7.5cm × 10cm)
 - ⑤ Watch (stopwatch)
 - 4) Linesman
 - ① Linesman armband
 - ② Marker
 - ③ Measuring tool (7.5cm × 10cm)

〔Ⅲ〕 Basic Progress of the Game

1. Preparing for the Game (Article 5 of the Rules)

- (1) Inspecting the ground
 - 1) The referee inspects the ground (Article 1 of the Rules).
- (2) Receiving and confirming the playing order sheet
 - 1) The referee receives the playing order sheets from the captain of each team.
 - 2) The chief referee and the assistant referee confirm the details on the playing order sheets and then hands them to the recorder.

Sample Playing Order Sheet – Details to be entered

- ・ The name of the team
- ・ The names of the manager, the players, and the substitute players
- ・ The captain's playing order number is circled (if the captain is a substitute player, then "Substitute 1" is circled)

オーダー表 <small>PLAYING ORDER SHEET</small>	
	チーム名 TEAM
打順 PLAYING ORDER	No. 競技者名 PLAYERS NAME
1 2	
3 4	
5 6	
7 8	
9 10	
交代1 ALT.1	
交代2 ALT.2	
交代3 ALT.3	
監督 MANAGER	

Figure 1 Playing Order Sheet

- (3) Deciding who goes first (Article 5, Clause 2 of the Rules)
 - 1) The leading team and the following team are decided by a coin toss conducted by the chief referee as follows.
 - ① The chief referee conveys, to the captains of both teams, which side

of the coin (which pattern) represents heads, and which represents tails.

- ② The chief referee chooses which team represents heads and which team represents tails, notifying this to the captains of both teams.
 - ③ The chief referee tosses the coin.
 - ④ The chief referee confirms which side of the coin is facing up, to announce which team has won the right to choose to lead or to follow.
 - ⑤ With a coin toss, the chief referee gets the captain of the team that won the right to choose to lead or follow to choose whether his/her team is the leading team or the following team. (Article 5, Clause 2 of the Rules)
 - ⑥ The captain of the team losing the right to choose to lead or follow with a coin toss chooses the waiting area (Article 1, Clause 2.2 of the Rules).
- 2) Once the leading team and the following team have been decided, the recorder enters the playing order on the record sheet.
- ① The recorder exchanges the playing order sheet of both teams, and hands the record sheet to the assistant referee.
- (4) Confirmations and inspections before the start of the game (Article 5, Clause 3 of the Rules)
- 1) A referee confirms and inspects the following before the start of the game.
 - ① The chief referee calls out “Line up in your designated positions”
 - ② A referee ensures that the manager and players of both teams line up.
 - ③ The chief referee calls out “We shall now confirm the stroking order and inspect the players’ equipment and clothing.”
 - ④ The chief referee first inspects the following team’s equipment and uniform.
 - a. Checks that the stick meets the standards set by the Rules.
 - b. Checks that the players are wearing the same uniforms.
 - c. Checks that the players are wearing athletic shoes.
 - ※ Checks that the heels are flat, and that they will not damage the ground.
 - d. Checks that the players are wearing the playing order numbers on the correct area of the body set by the Rules.

- e. Checks that the manager and the captain are wearing their identification on the correct area of the body set by the Rules.
- ⑤ The assistant referee checks the details of the leading team's playing order sheet and playing order, and hands the record sheet to the recorder. The check is first carried out on the captain of the leading team and then the players of that team. After the leading team members have been checked, a check is carried out on the captain of the following team and then the players of that team.
- a. Checks that there is no discrepancy between the playing order and the names of the players in the record sheet.
- ※ When confirming the captain, the assistant referee states “Captain”, and the captain then states his/her playing order by replying “Number ○” and then names himself/herself.
 - ※ When confirming anyone other than the captain, the assistant referee states the playing order number, substitution and manager, in that order, after which the corresponding player, substitute player and manager name themselves.
- b. Checks that there is no discrepancy between the playing order and the playing order worn by the players.

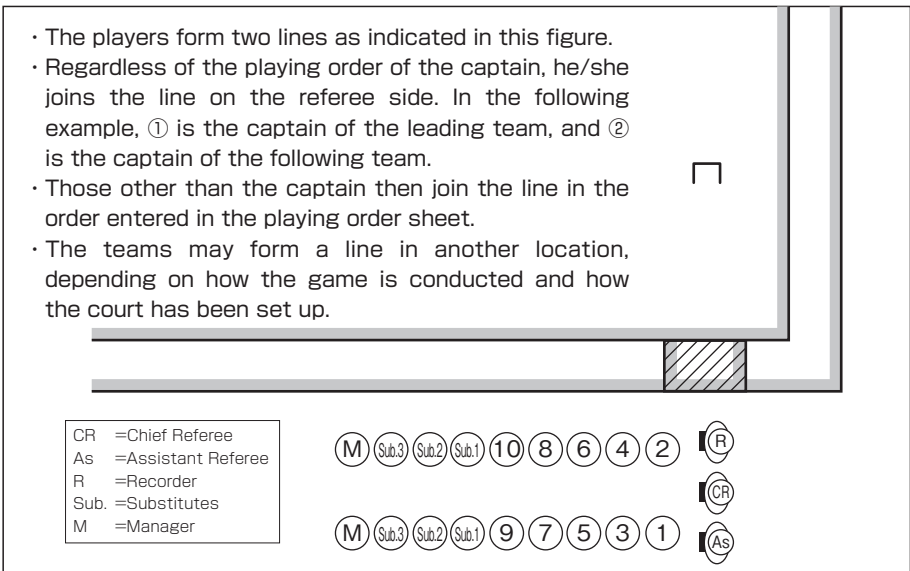

Figure 2 Lining up before the start of the game (Example)

- (5) Points to be aware of during the game
- 1) The chief referee ensures that both teams strictly observe the following.
 - ① The basic conditions to be observed by the manager and players (Article 4, Clause 4 of the Rules)
 - ② Any agreed items
- (6) Introductions and greetings
- 1) Referees introduce and greet both teams before the start of the game, as follows.
 - ① Chief referee – “The match between Team ○○, the leading team and Team △△, the following team, will now begin.”
 - ② Chief referee – “My name is ○○, and I will be the chief referee.”
 - ③ Assistant referee – “My name is ○○, and I will be the assistant referee.”
 - ④ Recorder – “My name is ○○, and I will be the recorder.”
 - ⑤ Linesman – “My name is ○○, and I will be the linesman.”
 - a. To be omitted if there is no linesman.
 - b. If there are several linesmen, then each calls out, “My name is ○○, and I will be the linesman.”
 - ⑥ Chief referee: “Can both teams bow to each other.”
 - a. If there is time before the start of the game, the chief referee calls on both teams to do warm up exercises.

2. Standing by at the End of Preparations for the Game

- (1) Lining up in position for the start of the game
- 1) The referee instructs both teams to line up in position for the start of the game, as follows.
 - ① The chief referee calls out, “Starting players please line up in the game start position.”
 - ② The referee instructs the starting players to line up in the free zone outside the fourth line.
 - ③ The referee gets the manager and substitute players to move to the waiting area.
 - 2) The chief referee, the assistant referee, and the recorder are positioned as indicated in Figure 3.
 - ① At this point, the assistant referee confirms the playing order

numbers and ball numbers.

- ② The recorder (or the linesman) is positioned in the outer field.

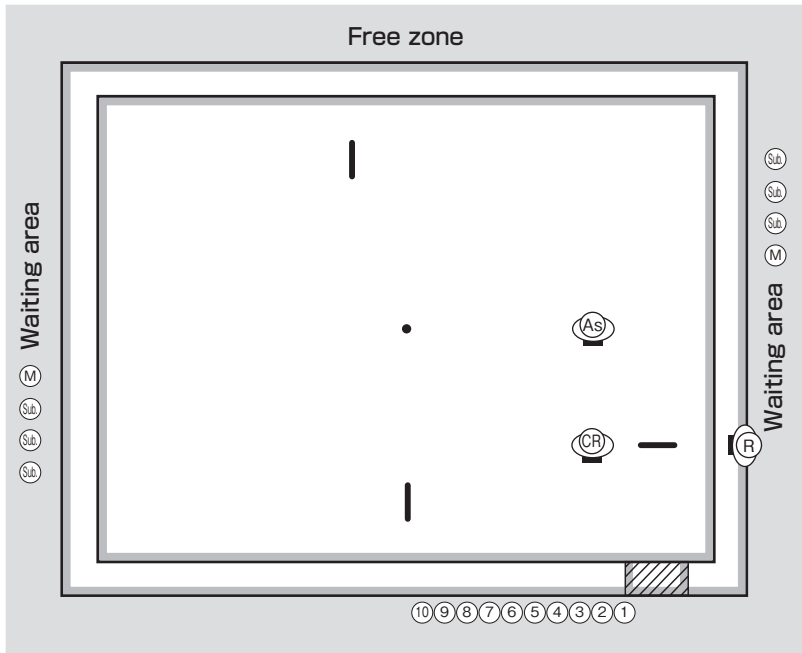

Figure 3 Positioning at the start of the game

3. Start of the Game (Article 6, Clause 3 of the Rules)

(1) Announcing “Play Ball”

- 1) Once a “Start of the Game” sign is received, the chief referee announces “Play Ball”.

- ① The chief referee faces the starting players and announces “Play Ball” in the direction of the 5th and 6th players.

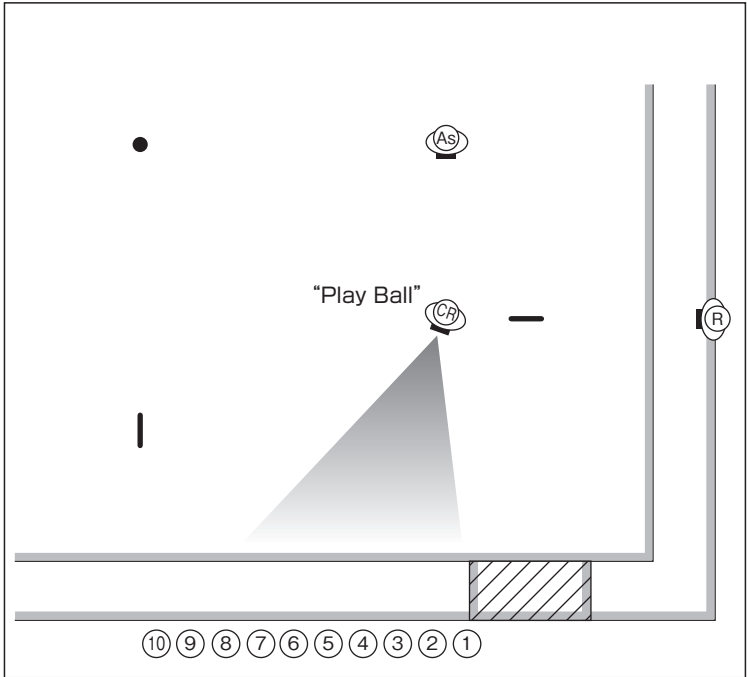

Figure 4 Positions of the chief referee, the assistant referee, and the recorder when announcing “Play Ball”

4. End of the Game (Article 6, Clause 4 of the Rules)

(1) Announcing Game Set

1) Once the “Game Set” sign is received, and the last stroker’s turn has finished, the chief referee announces “Game Set”.

① “Game Set” is announced with the chief referee standing in the center of the court and facing the start area.

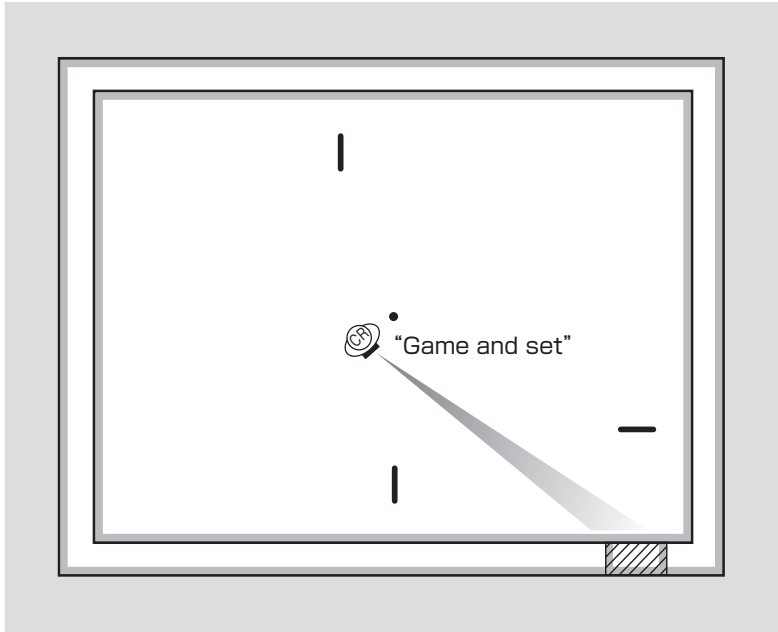

Figure 5 Position of the chief referee when Game Set is announced

- 2) The game is over when the following takes place.
 - ① If time is up after the leading team's playing order is called and before the following team's playing order is called, at the point that the next stroker from the following team's turn has finished.
 - a. If the next stroker from the following team's move results in an out-ball, finish ("agari") or the stroker is absent, at the point that the stroker from the leading team's turn has finished.
 - ※ In this case, the chief referee calls out "Number ○ Out-ball" (gesture unnecessary) and then announces "Game Set".
 - ② If time is up after the following team's playing order is called and before the leading team's playing order is called, at the point that the stroker from the following team's turn has finished.
- 3) If the "time up" sign and the playing order announcement by the chief referee take place simultaneously, the chief referee's playing order announcement takes priority.

5. Substitution of Players (Article 6, Clause 6 of the Rules)

(1) Substitution of a player

- 1) A substitution is permitted if the following procedures are followed.
 - ① The manager notifies the recorder of a player substitution.
 - ② The recorder confirms the substitution as follows, and advises the chief referee of the substitution.
 - a. If a substitution is notified before the playing order of the player to be substituted is called, the substitution is confirmed, and the chief referee advised of the substitution when the player to be substituted is called to stroke. In this case, the time from the point the recorder advises the chief referee of the substitution until the point the chief referee announces the substitution is regarded as the referee time.
 - b. If a substitution is notified when the player to be substituted is called to stroke, the substitution is confirmed on the spot, and the chief referee advised of the substitution. In this case, the time from the point the recorder is notified of the substitution until the point the chief referee announces the substitution is regarded as the referee time.
 - ③ The chief referee approves the substitution, and announces “Kotai”.
- 2) Substitutions are not approved in the following situations.
 - ① If the notice of substitution is received after the player to be substituted strokes, but before his/her turn is over.
 - ② If, when the player to be substituted is called to stroke, and the substitute player who is about to enter the ground is not wearing the corresponding playing order number.
 - a. The referee (refer 〔Ⅳ〕 1. (1)) calls on the player who is to be substituted to play, and counts 10 seconds.
- 3) If, before the next stroker plays, or before a foul, it becomes apparent that the player is playing without having notified the recorder of the substitution, this represents an ineffective play and the chief referee and the assistant referee carry out the following.
 - ① If a player who has played without notifying his/her substitution is on the court, that player is ordered to leave the court.
 - ② All balls are returned to where they were before they moved.
 - ③ If the next player is not called, then that player is called.

- 4) A player who has already been substituted and then plays again during the same game represents non-eligible participation (Article 8, Clause 2.1.(3) of the Rules), and the chief referee declares the other team as the winner by forfeit.

6. Absence of Players (Article 6, Clause 7 of the Rules)

- (1) Absence of a player
 - 1) The following applies if the manager notifies the referee that a player is absent.
 - ① Confirms the playing order number of the absent player.
 - ② The recorder records the absence.
 - ③ The game continues, with the playing order of the absent player recorded as a missing number.
 - a. The ball belonging to the absent player remains as is.
 - b. Points accumulated by plays by all players using the ball belonging to the absent player are valid.

7. Deciding the Winner (Article 7 of the Rules)

- (1) Confirmation of record game results
 - 1) The referee confirms the record game results on the recorder's record sheet as follows.
 - ① The chief referee announces, "Please place the ball in the position at the start of the game. Line up in your designated positions."
 - ② The assistant referee gets the managers and the players of both teams to line up.
 - ③ The chief referee receives the record sheet from the recorder, and confirms the contents.

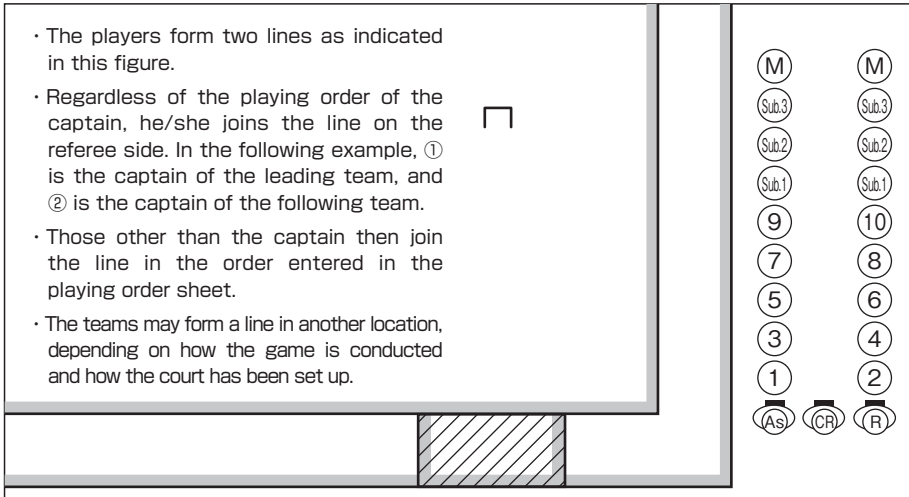

Figure 6 Lining up after the end of the game (Example)

(2) Deciding the Winner

- 1) Based on the record game results the chief referee decides on the winner as follows:
 - ① “I shall now announce the result of the game”
 - ② “Leading Team ○○ , ○ points”
 - ③ “Following Team △△ , △ points”
 - ④ “Team ○○ wins”
 - ⑤ “Now please bow to the other team.”
- 2) After the final greeting, the chief referee circles the winning team’s final score, and collects the signatures of confirmation on the record sheet from the captains of both teams. (Article 4, Clause 2.2.(4) of the Rules)

8. Deciding the Winner When Points are Tied

- (1) Deciding the winner based on the details of the points
 - 1) If both teams score the same number of points, the chief referee determines the winner according to the details of the points, as follows. (Article 7, Clause 2.1 of the Rules)
 - ① “I will now announce the result.”
 - ② “Leading Team ○○ , ○ points”

- ③ “Following Team △△ , △ points”
 - ④ “Team oo wins as a result of the details of the points (the number of agari / players successfully passing through the o Gate).”
 - ⑤ “Now please bow to the other team.”
- (2) Deciding the winner with a tiebreaker
- 1) If the winner cannot be decided from the details of the points, the winner shall be decided as follows.
 - ① The chief referee makes the following announcement: “As the winner can not be decided from the details of the points, there will be a tiebreaker”.
 - ② The referee instructs the players who were playing at the time the game ended to line up in their positions at the start of the game.
 - a. An absent player at the time the game ends can not be replaced with another player.
 - ③ Both teams must then compete to achieve a successful pass through the first gate. (Article 7, Clause 2.2.(1) of the Rules)
 - a. The chief referee announces the playing order from number 1 to 10, stands before the players, and makes an accurate decision on the play, and decides on and announces the successful pass through the first gate.
 - b. The assistant referee stands in a position in the direction of the stroke and makes a decision on the movement of the ball/s. If the ball has successfully passed through the first gate, the assistant referee hands the ball to the recorder. Any balls that have not successfully passed through the first gate are removed from the field.
 - c. The recorder positions himself/herself between the first gate and the goal-pole, at a distance of approximately 3 meters from the first gate, and repeats the announcement of a successful pass through the first gate. After ticking the tiebreaker column in the record sheet, the recorder then places the ball handed over by the assistant referee in a position that won't hinder the game.
 - ※ “A position that won't hinder the game” is a position where the ball that has successfully passed through the first gate can be easily confirmed by the players, and which won't obstruct the next pass through the first gate.

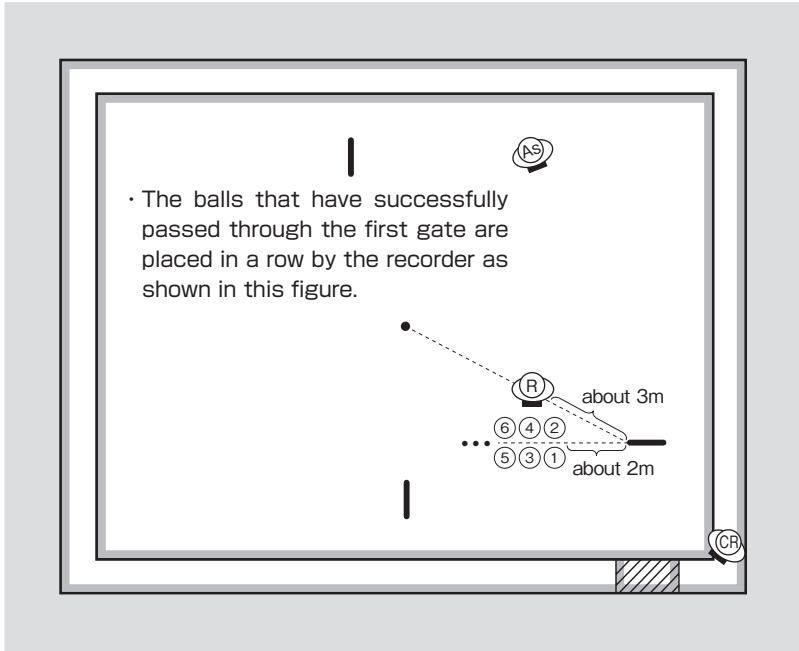

Figure 7 The position of the recorder and the placement of the balls during a tiebreaker (Example)

- ④ After player number 10's turn ends, the team with the most number of balls that have made a successful pass through the first gate wins, with the chief referee determining and calling the winner.
 - a. If the winner is determined before player number 10 strokes, the game ends at that point.
- ⑤ If the winner is not determined even after a tiebreaker involving players 1 to 10, player 1 and player 2 according to the playing order sheet then compete for a successful pass through the first gate, and the team of the player who first achieves a successful pass becomes the winner. If a winner still cannot be determined, the next two players according to playing order will compete one on one in attempting to successfully pass through the first gate. The process continues until a winner can be determined. (Article 7, Clause 2.2.(2) of the Rules)

- a. If a player is absent, then at the point that the next player from the opposing team achieves a successful pass through the gate, that team becomes the winner.
- 2) Once the tiebreaker is over, the chief referee decides on the winner as follows.
 - ① “I will now announce the result.”
 - ② “Leading Team ○○ , ○ points”
 - ③ “Following Team △△ , △ points”
 - ④ “Team ○○ wins as a result of a tiebreaker.”
 - ⑤ “Now please bow to the other team.”
- (3) When points are tied
 - 1) If the winner cannot be determined based on the score achieved, the chief referee may declare a tie without deciding the winner with a tiebreaker, as follows. (Article 7, Clause 2.3 of the Rules)
 - ① “I will now announce the result.”
 - ② “Leading Team ○○ , ○ points”
 - ③ “Following Team △△ , △ points”
 - ④ “A tie as all the details of the points are the same. ”
 - ⑤ “Now please bow to the other team.”

9. Perfect Game (Article 7, Clause 3 of the Rules)

- (1) Ending the game when a perfect game has been achieved
 - 1) If a perfect game has been achieved, the game ends at the following point, with the chief referee announcing “Game Set” and deciding on the winner.
 - ① If the leading team achieves a perfect game as the result of a play by a stroker in the leading team, when the player in the following team’s turn has ended.
 - ② If the following team achieves a perfect game as the result of a play by a stroker in the leading team, when that stroker’s turn has ended.
 - ③ If the leading team achieves a perfect game as the result of a play by a stroker in the following team, when that stroker’s turn has ended.
 - ④ If the following team achieves a perfect game as the result of a play by a stroker in the following team, at that point.
 - ※ If, in ② and ③ , the stroker gains the right for continuous play or to stroke, that stroker continues to play, and the game ends

when that stroker's turn has ended.

- ※ If both teams achieve 25 points, the winner shall be decided by a tiebreaker, or the game shall end in a tie. (Article 7, Clause 2.2 and 2.3 of the Rules)

10. Forfeit

(1) Abandonment (Article 8, Clause 1 of the Rules)

- 1) If it is made apparent, before the start of the game, that the game is being abandoned, the chief referee will interpret this as the game being forfeited, and determines the winner.
 - ① If the team announces its intention to abandon the game
 - ② If the team has less than five players at the start of the game (when Play Ball is announced)
- 2) If the team announces its intention to abandon the game during the actual game, the chief referee will interpret this as forfeiting the game, announces "Game Set" and instructs the players to line up where they would at the end of the game, and announces the winner.

(2) Non-eligible participation (Article 8, Clause 2 of the Rules)

- 1) If it is made apparent, during a game, that a non-eligible player is participating in that game, the chief referee will interpret this as forfeiting the game, announces "Game Set" and instructs the players to line up where they would at the end of the game, and announces the winner.
 - ① If anyone other than those listed in the playing order sheet plays in the game.
 - ② If a player plays with equipment and/or uniform that does/do not comply with the requirements of the inspection held before the start of the game.
 - ③ If a player who has already been substituted plays again during the same game.

11. Play and Rights as a Stroker (Article 9, Clause 1 of the Rules)

(1) The stroker's entrance into and exit out of the court

- 1) A stroker can only enter the court after the chief referee calls on that stroker to play.

- ① The referee must not allow anyone other than the stroker to enter the court.
 - a. Should someone else enter the court, the referee shall ask them to leave.
 - b. If a member of the same team does not adhere to any warnings issued by the referee, this will be interpreted as Play Interference by the chief referee.
- 2) The referee instructs the player whose turn has ended to leave the court.
 - ① If the player whose turn has ended and is about to leave the court comes into contact with a ball, this shall be seen as an ineffective play. (Article 10, Clause 2 of the Rules)

12. Out-ball (Article 17, Clause 2 of the Rules)

- (1) Decisions and announcements on out-balls.
 - 1) Deciding on and announcing an out-ball shall be carried out by a referee other than Referee A. (IV 1. of the Guide for Referees)
 - ① Depending on the circumstances, Referee A can make the decision and the announcement.
 - 2) The decision of an out-ball is carried out as shown in the following figure.

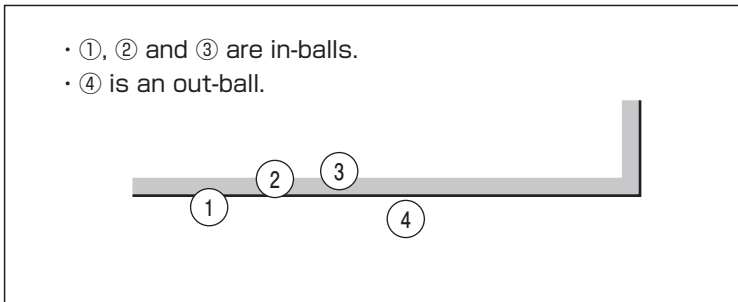

Figure 8 Decision on an out-ball (Example)

- 3) When a stroker tries to make another ball an out-ball as the result of a Spark, the chief referee and the assistant referee first confirm the direction of the Spark, after which a referee other than Referee A stands by in the outer field.

(2) Dealing with an out-ball

1) A referee other than Referee A deals with the out-ball.

- ① Depending on the circumstances, the chief referee or the assistant referee can ask a player who will not hinder the game to stop the out-ball.
 - a. The referee must consider the safety of the player/s.
 - b. The referee handles the out-ball once a player has stopped an out-ball.

2) After stopping the out-ball with his/her foot, the referee places the out-ball with its outer edge at a distance of 10 centimeters perpendicular to the outside of where the ball crossed the inside line and entered the outer field. (Article 17, Clause 2.2 of the Rules)

- ① Even if a ball that has gone to the outer field and has been decided and announced as an out-ball moves back to enter the inner field because of the condition of the court, for example, the referee treats and places that ball as an out-ball from the position it ended up in after passing over the inside line and entering the outer field.
- ② If a stroker strokes an out-ball but it did not enter the inner field, the referee announces “out-ball” and places the ball in the position it was in before it moved.

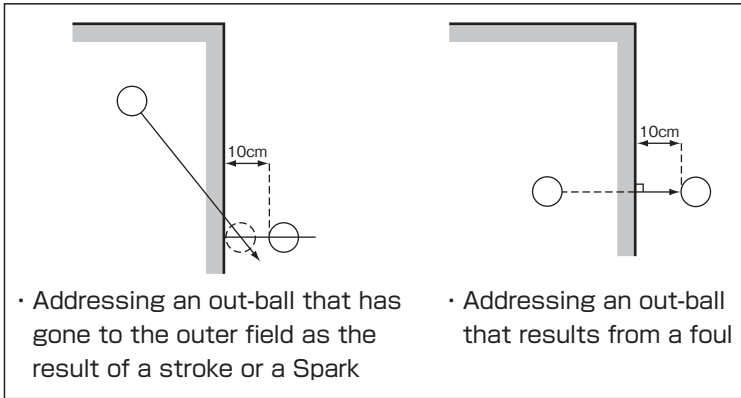

Figure 9 Addressing an out-ball (Example)

13. Play Interference (Article 19 Clause 1 of the Rules)

- (1) Preventing play interference
 - 1) If a manager or player does not comply with the basic conditions to be observed by the manager and players as set out in Article 4 Clause 4, the referee issues a warning to that manager or player and his/her team to prevent play interference.
- (2) Play interference
 - 1) The following represent examples of play interference.
 - ① If a member/members of a team does/do not comply with a warning by the referee.
 - ② If it is decided by the chief referee or assistant referee that a manager or player has interfered with the game.
- (3) Addressing Play Interference
 - 1) In the event of play interference, in order to prevent the offending team from benefiting from the interference, the chief referee carries out the following, depending on the circumstances at the time.
 - ① Takes away stroking rights
 - ② Makes the ball an out-ball
 - ③ Disallow successful passes through gates, and finishes (“agari”)
 - ④ Eject the manager or player/s from the game
 - a. The ball of a player who has been ejected is removed from the field.
 - b. The playing number of the player who has left the field is recorded as a missing number.
 - c. Any points obtained prior to being removed from the game shall be valid
 - ⑤ Forfeiture of the Game
 - a. In the event that a team doesn’t comply with the chief referee despite being ordered to continue with the game, and the game is forfeited.
 - b. In the event that the game is forfeited, the chief referee announces “Game Set”, instructs the players to line up where they would at the end of the game, and announces the winner.

14. Referee Time (Article 20, Clause 1 of the Rules)

(1) Referee Time

- 1) Although referee time is excluded from the 10 second count, it is included in the game time.
 - ① The referee must endeavor to reduce referee time.
- 2) Referee time refers to the following time taken for an action approved by the referee:
 - ① The time between the end of a stroker's turn until the next stroker is called.
 - ② The time that the chief referee or assistant referee makes the stroker wait before stroking (or sparking).
 - ③ The time required for the chief referee or assistant referee to temporarily move a ball.
 - ④ The time required by the chief referee or assistant referee to return a ball that has made an invalid move to where it was before it moved.
 - ⑤ The time required by the chief referee or assistant referee to confirm the game record.
 - ⑥ The time required to approve and announce substitutions.
 - ⑦ The time required by the chief referee or assistant referee to respond to a question by a manager or a confirmation by a stroker.
 - ⑧ The time required to exchange balls.
 - ⑨ The time required by the referee to repair the ground.
 - ⑩ Any other time that is required for a move or action allowed by the referee.

15. Exchange of Equipment (Article 21 of the Rules)

(1) Exchanging the stick

- 1) The referee only allows the exchange of sticks that have already been inspected before the start of the game if a stroker requests it .
 - ① The time required to exchange the stick is not included in Referee Time.
- 2) The following applies in the event that a stick breaks.
 - ① The play that has just ended is not repeated (and the record also remains valid).
 - ② If the player has the right for continuous play or the right to

spark, then he/she exchanges his/her stick.

(2) Exchanging the ball

- 1) If a crack appears in a ball, this is still deemed valid play, and that ball is only exchanged after all the balls have stopped moving.
- 2) If the ball splits, this is deemed ineffective play, and any balls that have moved as the result of the cracked ball are returned to the positions they were in before moving, the cracked ball exchanged, and the player instructed to stroke one more time.

16. Interruption of the Game (Article 22 of the Rules)

(1) Interruption of the Game

- 1) Should it become impossible for the game to continue due to a sudden change of weather or other emergency reasons, the chief referee shall call “Time” and temporarily interrupt the game.

- ① Depending on the circumstances, a doctor or other related personnel should be contacted immediately.
- ② The ball is left as is.
- ③ The recorder stops measuring the time when the chief referee calls out “Time”, and enters, into the remarks column on the record sheet, the time that the game was interrupted, the reason, and the words “game interruption”.

(2) The measures to be taken after a game has been interrupted

- 1) If, after being interrupted, the game can then be resumed, the chief referee announces “Play” while the game is still interrupted, after which the game resumes.

- ① Once the chief referee announces “Play”, the recorder then recommences measuring the time, and enters, into the remarks column on the record sheet, the time that the game resumed, and the words “game recommences”.

- 2) If the game has been interrupted before 20 minutes has passed since the start of the game, and resuming the game is not possible, the game shall be postponed, and that game replayed from the beginning.

- ① The recorder shall enter, into the remarks column on the record sheet, the reason for the postponement of the game, and the words “game postponed.”

- 3) If the game has been interrupted after 20 minutes has passed since the start of the game, and resuming the game is not possible, the game then becomes a called game, with the game ending with the score at the time that the game was interrupted.
- ① The recorder enters, into the remarks column on the record sheet, the reason for the called game, and the words “called game.”

17. Refereeing Errors

(1) Refereeing Errors

- 1) A referee must avoid, at all times, hindering the game through his/her error.
- ① If an error is made in a stroking call, decision, announcement or in handling or addressing a ball, the error must be corrected immediately.
- ② In the following case, however, the game shall continue even if the referee makes an error.
- a. If an error is made in a stroking call, decision, announcement or in handling or addressing a ball, and the game continues to be played, and the next stoker that is called strokes, or his/her move results in a foul, the game continues as is.
- b. If a player enters the game as a substitute without notifying the recorder of the substitution, and the next player strokes, or his/her move results in a foul, the game is continued as is.
- ※ In this case, at the point that it is made apparent that the player has played without notifying his/her substitution, the referee cautions that player to notify the substitution, the recorder is notified by the manager and advises the chief referee of the substitution, and the chief referee approves and announces the substitution after that player has been called to stroke.
- c. If the recorder has been notified of a substitution but fails to advise the chief referee, and the player is substituted without approval or being announced, and he/she strokes, or his/her move results in a foul, the game is continued as is.
- ※ In this case, if it is made apparent that the player, during his/her play, has played without his/her substitution being

approved or announced, the recorder advises the chief referee of the substitution and the chief referee approves and announces the substitution at that time.

※ If it is made apparent that the player has played without his/her substitution being approved or announced after the next stroker has been called to stroke, the recorder advises the chief referee of the substitution and the chief referee approves and announces the substitution after that next stroker has been called to stroke.

③ If the referee touches a ball by mistake, the following applies.

- a. If he/she touches a stationary ball, that ball is immediately returned to the position it was in before it moved.
- b. If he/she touches a ball while it is moving, it is regarded as a valid move until it stops moving.

※ If a ball that looks as though it will be going to the outer field is stopped in the inner field, that ball becomes an out-ball.

〔IV〕 Basic Interaction between the Chief Referee and the Assistant Referee

1. The Position of the Chief Referee and Assistant Referee When Making Decisions

- (1) The referee whose main role is to decide on a stroker's play is referred to as "Referee A".
 - 1) Referee A stands in front of the stroker.
 - ① The decision is made with the referee positioned at a sufficient distance from the stroker so that the stroker does not feel hemmed in.
- (2) The referee whose main role is to decide on the movement of a ball is referred to as "Referee B".
 - 1) Referee B stands in the direction that the stroker is stroking.
 - ① The decision is made from a position that will not affect the play by the stroker.

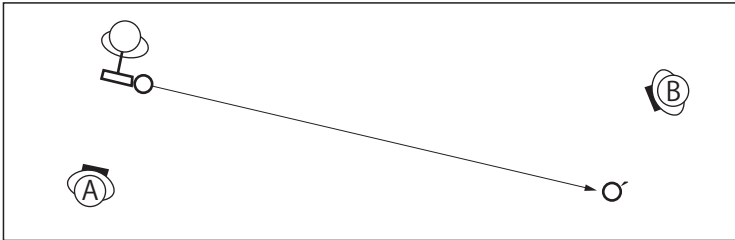

Figure 10 Positions of Referees A and B when making a decision

- (3) Making decisions and announcements on the stroker's play
 - 1) Referee A makes decisions and announcements on the stroker's play
 - ① Depending on the circumstances, Referee B can makes decisions and announcements on the stroker's play.

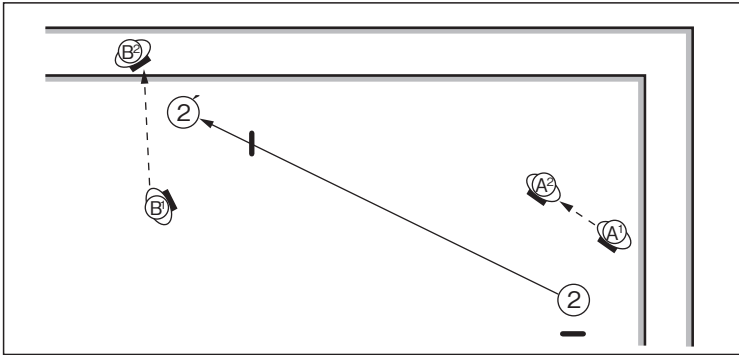

Figure 11 Referee B making a decision and announcement (Example)

- (4) Exchange of roles between Referee A and Referee B
- 1) The chief referee and the assistant referee can, depending on the circumstances surrounding the stroker's play, exchange their roles.

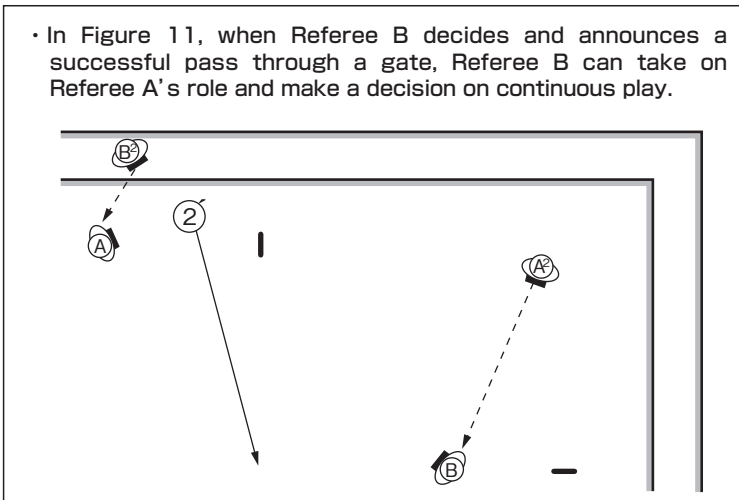

Figure 12 Referee A and Referee B exchanging roles (Example)

2. The Interaction Between the Chief Referee and Assistant Referee in Relation to Stroking Notifications

- (1) Mutual confirmation of the next player
 - 1) Once a stroker's turn ends, the chief referee and assistant referee mutually confirm the position of the next stroker's ball.
 - ① Basically, the position of the next stroker's ball is confirmed by the assistant referee and conveyed to the chief referee.
 - a. The position of the ball, but not the number of the next player, is conveyed.
 - (2) Timing of the call to stroke
 - 1) Once a stroker's turn ends, the chief referee calls the next stroker to stroke.
 - ① The stroker's turn ends when the following takes place.
 - a. After stroking, the stroker does not gain the right for a continuous play or (a Spark), and all the balls in the inner field that have made a valid move stop moving.
 - b. When a play results in a foul.
 - ② Even before a ball in the inner field is still moving, if the chief referee decides that the situation remains unchanged, he/she can call the next player to stroke.
 - 2) A call to stroke made when the chief referee is near the ball of the next stroker
 - ① The chief referee takes the shortest route to arrive at a position that will enable him/her to decide on the play by the next stroker, calls on that player to stroke, and becomes Referee A.
 - ② The assistant referee takes the shortest route to arrive at a position that will enable him/her to decide on the movement of the ball, and becomes Referee B.

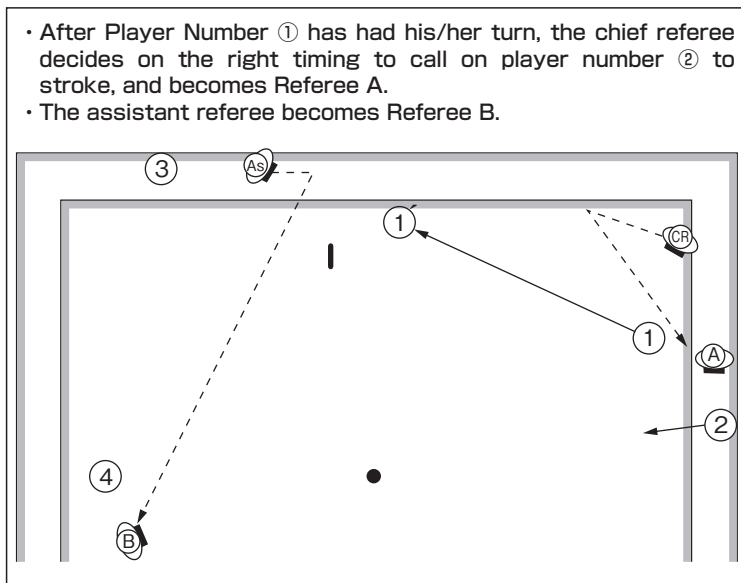

Figure 13 The interaction between the chief referee and the assistant referee when the chief referee is near the ball belonging to the next stroker (Example)

- 3) A call to stroke made when the assistant referee is near the ball belonging to the next stroker
 - ① The chief referee decides on the right timing for the assistant referee to take the shortest route to arrive at a position to decide on a play by the next stroker, and makes the call to stroke. He/she him/herself takes the shortest route to arrive at a position to decide on the movement of the ball, and becomes Referee B.
 - ② The assistant referee takes the shortest route to arrive at a position to decide on a play by the next stroker, and becomes Referee A.

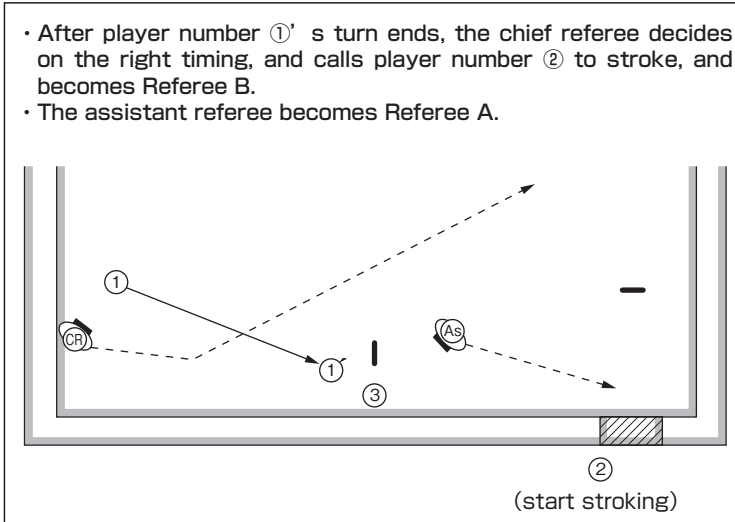

Figure 14 The interaction between the chief referee and the assistant referee when the assistant referee is near the ball belonging to the next stroker (Example)

3. What the Chief Referee and Assistant Referee Should Be Aware of Regarding the Play and Rights of the Stroker

- (1) Time Over (Article 9 Clause 2 of the Rules)
 - 1) Referee A starts counting the 10 seconds, and at the 8 second mark, calls out “8 seconds, 9 seconds, 10 seconds”. If a stroke (or Spark) does not take place during the call, the referee calls out “Foul”.
 - ① The following marks the beginning of the 10 second count.
 - a. When a player is called to stroke
 - b. When the stroker gains the right for continuous stroke
 - c. When the stroker gains the right to spark
 - ② The 10 second count continues even if the stroker who has gained the right for continuous play (or the right to spark) exits the court.
 - (2) Confirmation by the stroker (Article 9 Clause 3 of the Rules)
 - 1) The chief referee or assistant referee shall respond to a stroker when asked to confirm the following.
 - ① Whether a ball which has stopped on the gate line then moves to the back side and completely passes over the gate line represents a

successful pass through the gate

- ② Whether the set ball is on the gate line
 - ③ Whether a ball that has made a successful pass through the third gate is in contact with the goal-pole
 - ④ Whether the stroker's ball and another ball are in contact when stroking one's own ball
 - ⑤ Which number ball resulted in a successful Touch
 - ⑥ Whether the stroker's ball and the touched ball are in contact following a Touch
 - ⑦ Whether the touched ball and yet another ball are in contact following a Touch
- 2) The referee should always confirm the situation, regardless of whether he/she has been asked to do so by the stroker.
 - 3) The time required for the chief referee or assistant referee to respond constitutes referee time.
 - ① The time required for the chief referee or assistant referee to confirm the matter with the recorder constitutes referee time.
 - ② The time taken by the stroker to confirm a point is not included in referee time.

4. Interaction Between the Chief Referee and Assistant Referee at Stroking

- (1) Stroking (Article 12, Clause 1 of the Rules)
 - 1) Referee A announces "End of Stroke" to prevent a stroker whose turn has ended from stroking his/her ball in the following situations.
 - ① The stick face comes into contact with the stationary stroker's ball when stroking or repositioning the stroker's ball, after which the stroker whose turn has ended attempts to stroke again.
 - ② After a continuous play and the stroker's turn has ended, that stroker then attempts to stroke his/her ball again.
- (2) Start stroking
 - 1) If, during start stroking, the stroker's ball is placed outside the start area and stroked, this represents a stroking foul. (Article 12, Clause 4.1.(10) of the Rules)
 - ① The stroker can use his/her hand to reposition his/her ball.

- a. It is a ball touch foul if the foot, etc is used to reposition the ball.
 - b. It is a stroking foul if the ball is repositioned using any part other than the stick face.
- ② It is not, however, a foul if the stroker's ball moves and comes into contact with the stick or foot as the result of, for example, the way the lines forming the start area have been set (Article 11, Clause 2.1.(10) of the Rules).

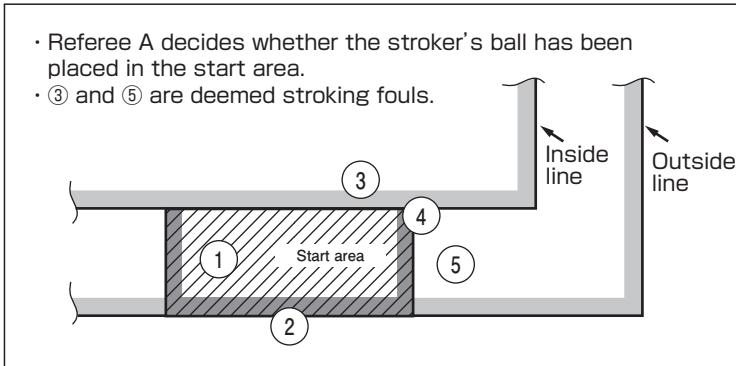

Figure 15 The correct and incorrect positions of the ball at start stroking (Example)

- 2) With regards to a ball that is obstructing a pass through the first gate, upon being requested by the stroker to temporarily move the ball, the chief referee or assistant marks that position and then temporarily moves the ball to a position that is not obstructing a pass through the gate. (Article 12, Clause 2.1.(2) of the Rules)
- ① After start stroking, the chief referee or assistant referee then returns the temporarily moved ball to where it was before it was moved.

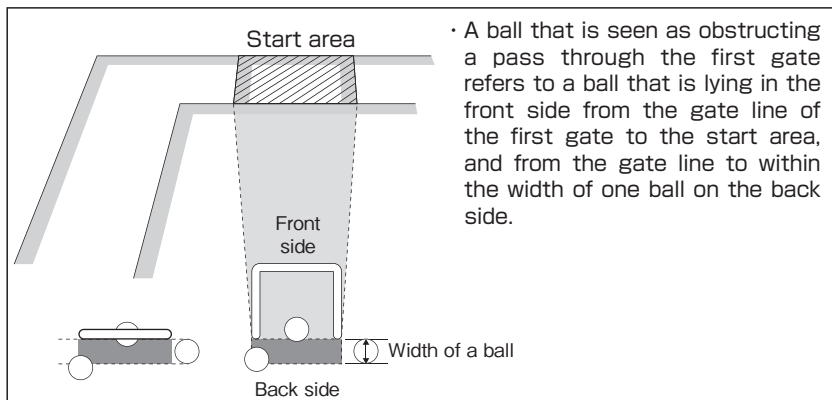

Figure 16 A ball that is obstructing a pass through the first gate (Example)

- 3) Deciding on and announcing a successful pass through the first gate (Article 13, Clause 1 of the Rules)
 - ① At the same time as making a decision on the validity of a stroke, Referee A proceeds in the direction of the ball.
 - ② As soon as it is confirmed that start stroking has resulted in the ball completely passing over the gate line of the first gate in a single stroke, Referee A calls out that the pass through the gate was successful.
 - a. Depending on the situation, Referee B may make the call.

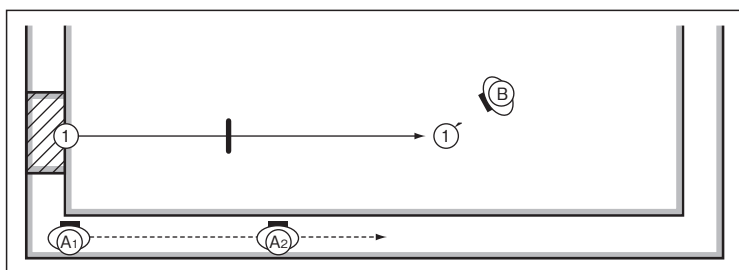

Figure 17 Interaction between the chief referee and the assistant referee at start stroking (Example 1)

- ③ If Referee B determines that the ball will stop in the outer field, he should already be positioned in the outer field.

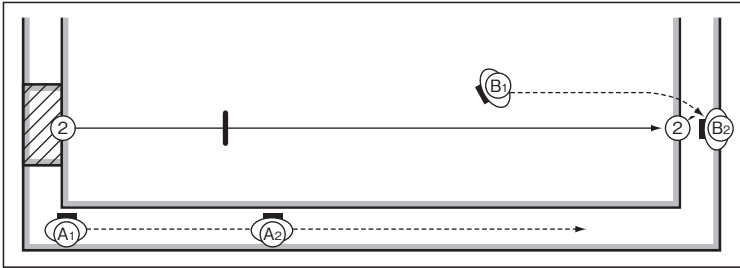

Figure 18 Interaction between the chief referee and the assistant referee at start stroking (Example 2)

- 4) Points to be aware of related to a successful pass through the first gate

- ① The following figure represents an example of a successful pass through the first gate.

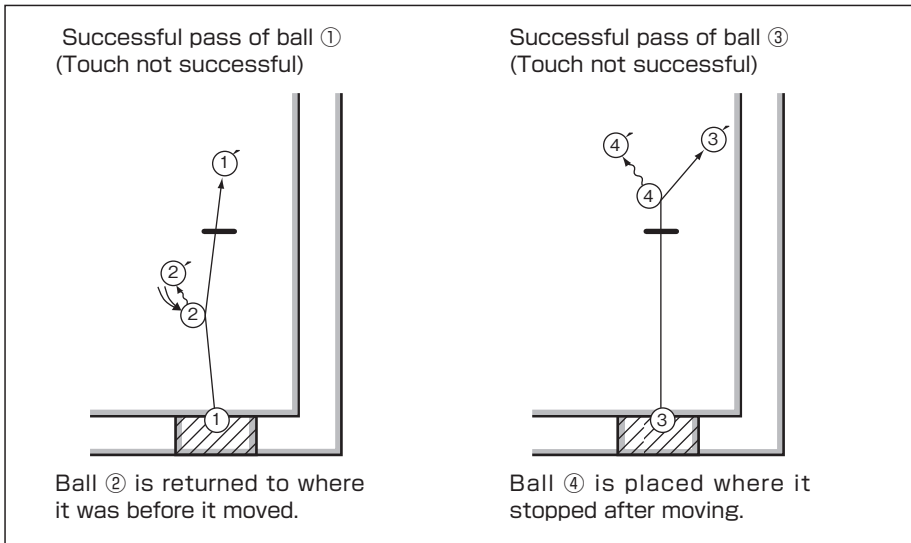

Figure 19 A successful pass through the first gate (Example 1)

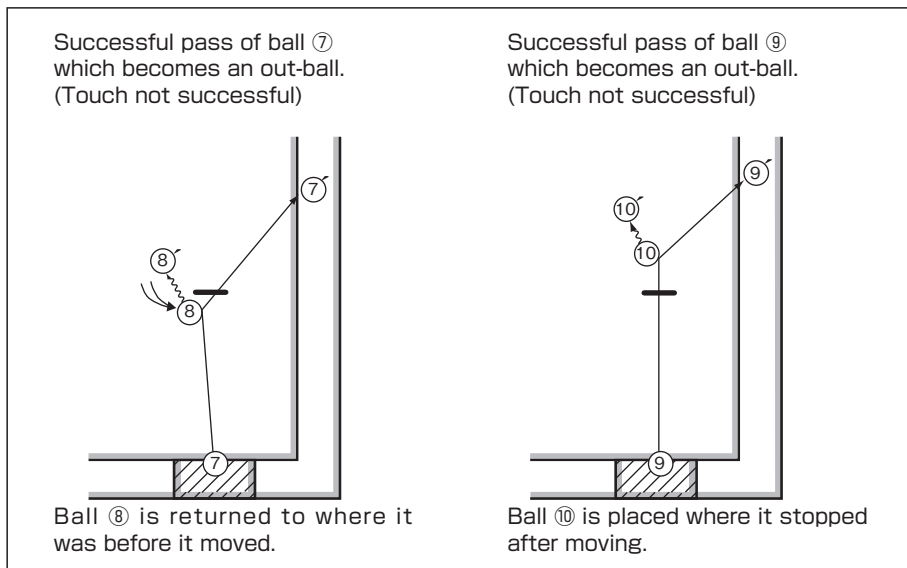

Figure 20 A successful pass through the first gate (Example 2)

5) Addressing a ball that did not make a successful pass through the first gate

- ① The referee removes, from the field, the ball that did not make a successful pass through the first gate.
 - a. The referee places the ball that did not make a successful pass through the first gate outside the court near the first gate.
 - ※ Depending on the situation, the ball can be removed to a position outside the court that is near where it was picked up.

(3) Stroking an out-ball

- 1) If the stroker requests Referee A to temporarily move an out-ball that is interfering with his/her play, Referee A first marks that position and then temporarily moves it to a location which won't interfere with the play. (Article 17, Clause 2.3 of the Rules)
 - a. Depending on the situation, Referee B temporarily moves the out-ball.

- ① The following are examples of an out-ball that interferes with a play.
 - a. A ball that obstructs the stroker's swing or stance
 - b. A ball that is in the path of the ball that is about to be stroked
- ② After the out-ball is stroked, Referee A returns the ball that was temporarily moved to where it was before it was moved.
 - a. Depending on the situation, Referee B returns the ball that was temporarily moved to where it was before it was moved.
- 2) If an out-ball (the stroker's ball) stroked by the stroker hits the gate (or goal-pole), which causes another ball in contact with this gate (or goal-pole) to be moved indirectly, the movement of that ball is invalid, and therefore the chief referee or assistant referee returns the ball to where it was before it moved. (Article 11, Clause 2.1.(4) of the Rules)
 - ① If it is determined that the stroker's ball hit the gate (or goal-pole) after hitting another ball, or that the ball simultaneously hit another ball and the gate (or goal-pole), this represents an out-ball stroking foul.
 - ② If the stroker's ball hits the gate (or goal-pole), which causes another ball in contact with this gate (or goal-pole) to be moved indirectly, and if the stroker's ball stopped in a position where this other ball was in (before it indirectly moved), this represents an out-ball stroking foul.
- 3) If the stroked out-ball does not enter the inner field, the referee announces "Out-ball", and the ball is returned to where it was before it moved.
 - ① If the stroked out-ball hits another ball (including an out-ball), this is an out-ball stroking foul and therefore "Foul" is announced, and it is treated as an out-ball from the position it was in when the foul took place. (Article 17, Clause 4 of the Rules)

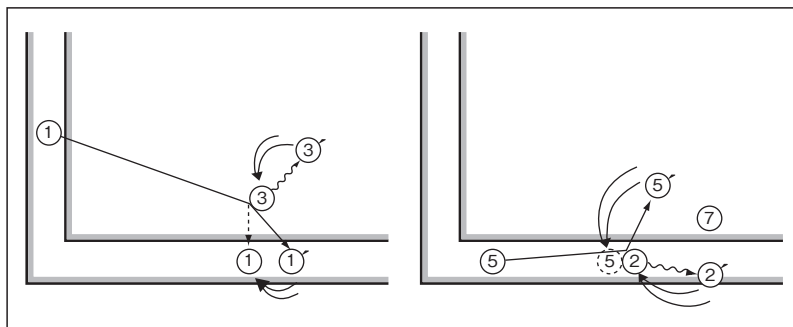

Figure 21 Fouls related to out-balls (Example)

5. The Interaction Between the Chief Referee and Assistant Referee in Relation to Continuous Stroke or Sparking

- (1) A pass through the gate
 - 1) Referee A must quickly make a decision and an announcement regarding a ball that passes through the second gate or third gate.
 - ① Depending on the situation, Referee B may make the announcement.

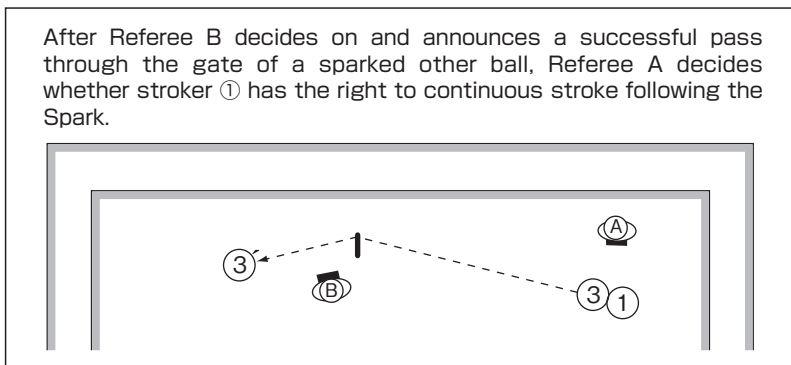

Figure 22 What happens when Referee B decides on and announces a successful pass through the gate (Example)

(2) A successful Touch and sparking

- 1) Referee A makes a decision on and announces a successful Touch.
 - ① Depending on the situation, Referee B may make the decision and announcement.
- 2) The chief referee and the assistant referee confirm the direction of the Spark if the stroker gains the right to spark following a Touch.
 - ① Referee B proceeds in the direction of the Spark.
 - a. The direction of the Spark is determined by the way the touched ball has been set.

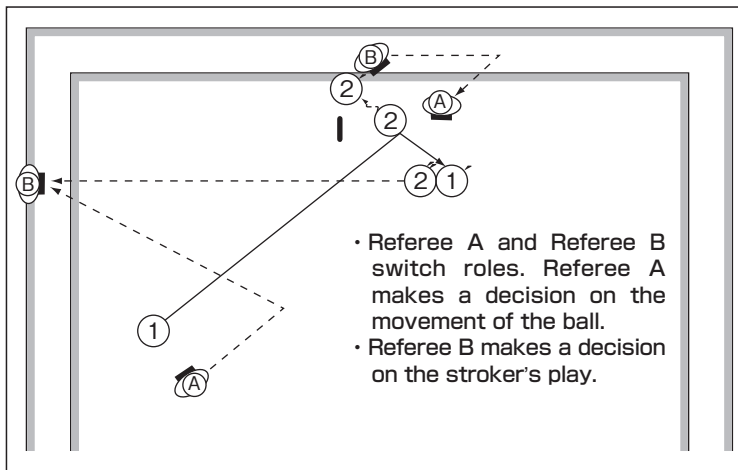

Figure 23 What happens when Referee B makes a decision on and announces a successful Touch (Example)

- 3) If Referee B has not yet proceeded in the direction of the Spark even though the stroker has set the other ball/s, Referee A carries out the following.
 - ① Asks the stroker to “Wait” before sparking.
 - a. The time a stroker is asked to wait constitutes referee time.
 - ※ Any play during that time shall be seen as ineffective. (Article 10, Clause 2 of the Rules)
 - ② Confirms that Referee B has proceeded to an appropriate position, and then says “Proceed” to call on the stroker to spark.

- (3) Points to be aware of related to sparking
- 1) Examples of invalid ball movements related to sparking. (Article 11, Clause 2.1.(9) of the Rules)
 - ① The stroker's ball and the touched ball contact each other and stop, and during the Spark, the stroker picks up the touched other ball, causing his/her ball to move.
 - ② The touched ball and another ball come into contact with each other and stop, and during the actions on sparking, the stroker picks up the touched ball, causing yet another ball to move.

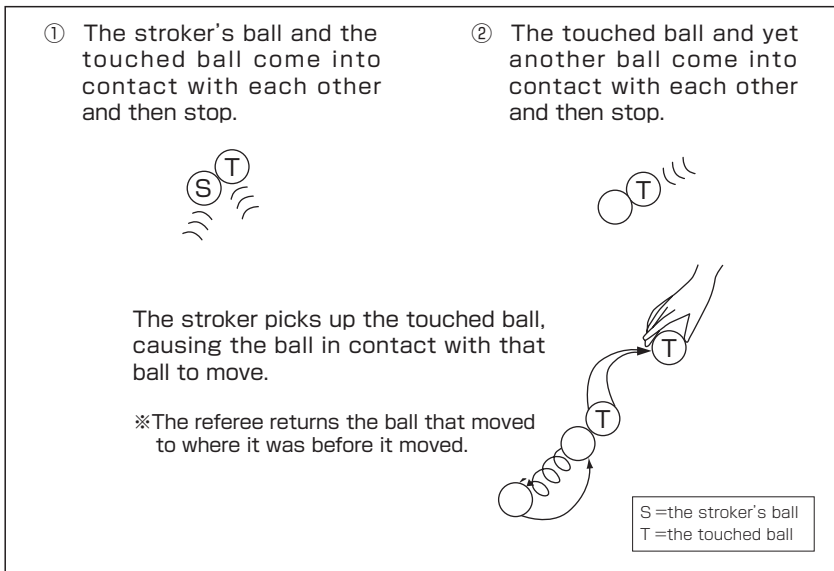

Figure 24 Invalid move as a result of picking up a touched ball (Example)

- ③ The stroker's ball and several touched balls come into contact with each other and stop, and the stroker picks up the touched ball to temporarily move that ball, causing his/her ball and another touched ball to move.
- a. After the Touch, Referee A is asked by the stroker to confirm whether the balls are in contact, and responds accordingly.
 - b. Referee A determines that the movement of the stroker's ball or a touched ball when the stroker temporarily moves the touched other ball is an invalid move, and returns the moved ball to where it was before it moved.
 - ※ If the stroker's ball and three or more touched balls contact each other and stop, the stroker can temporarily and simultaneously move two or more balls that are to be sparked later.
 - c. If Referee A determines that the location to which the stroker has moved a ball is interfering with the game, the referee can move the ball to another location.
 - ※ The time used in relocating the ball constitutes referee time.
 - d. If a foul occurs after the balls to be sparked second and third are temporarily moved by the stroker, Referee A returns the temporarily moved balls to where they were before being moved, and then addresses the foul.
 - e. If a sparked ball hits a ball that was temporarily moved, all balls that move as a result are seen as an invalid move, and are returned to their respective places before they moved by the chief referee or assistant referee. (Article 11, Clause 2.1.(8) of the Rules)
 - ※ The sparked ball is placed where it came into contact with the ball that was temporarily moved.

- ③ The stroker's ball comes into contact with multiple touched balls and stopped.



- The stroker temporarily moves the ball (B) which will be the second ball to be sparked in order to Spark ball (A).
- The stroker can temporarily and simultaneously move the balls (B and C) that are being stroked in the next two strokes in order to Spark ball (A).

If the referee determines that the position that the ball (B) has been temporarily moved to by the stroker will interfere with the game.

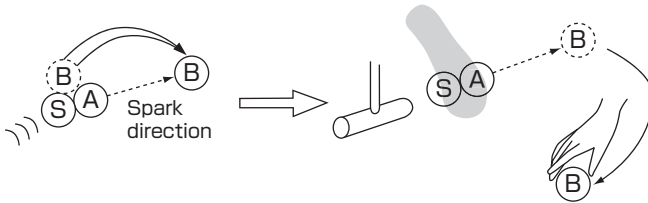

※ Referee A repositions the other ball (B) that was temporarily moved.

When a sparking foul takes place after the stroker temporarily moves the ball (B).

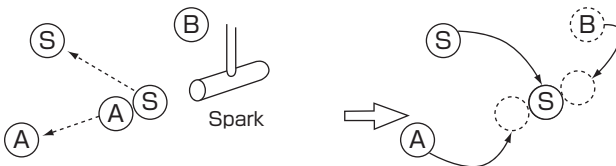

※ The chief referee and the assistant referee return the temporarily moved ball (B) to where it was before it moved, and then address the foul (makes the stroker's ball an out-ball).

Figure 25 What to do when a stroker temporarily moves a touched ball (Example)

- ④ During an action on sparking, the stroker drops a touched other ball that he/she picked up, and that ball touches a gate (or goal-pole), as a result of which the stroker's ball or another ball, which is in contact with that gate (or goal-pole), is indirectly moved.

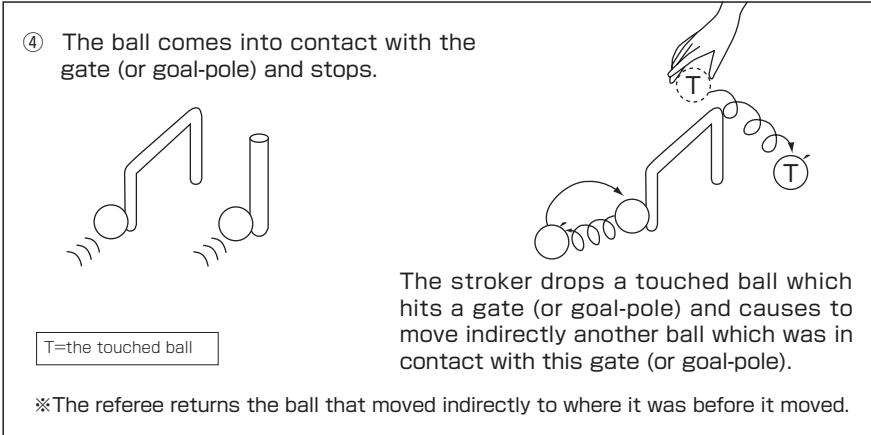

Figure 26 An invalid move caused indirectly by an action on Sparking (Example 1)

- ⑤ The stroker's ball and a touched other ball stop in contact with a gate (or goal-pole) and, during an action on sparking, the stroker picks up the touched other ball to indirectly move his/her ball.
- ⑥ A touched other ball stops in contact with a gate (or goal-pole) with which another ball is also in contact, and the stroker picks up that touched ball during an action on sparking, resulting in the other ball in contact with the gate (or goal-pole) to be indirectly moved.

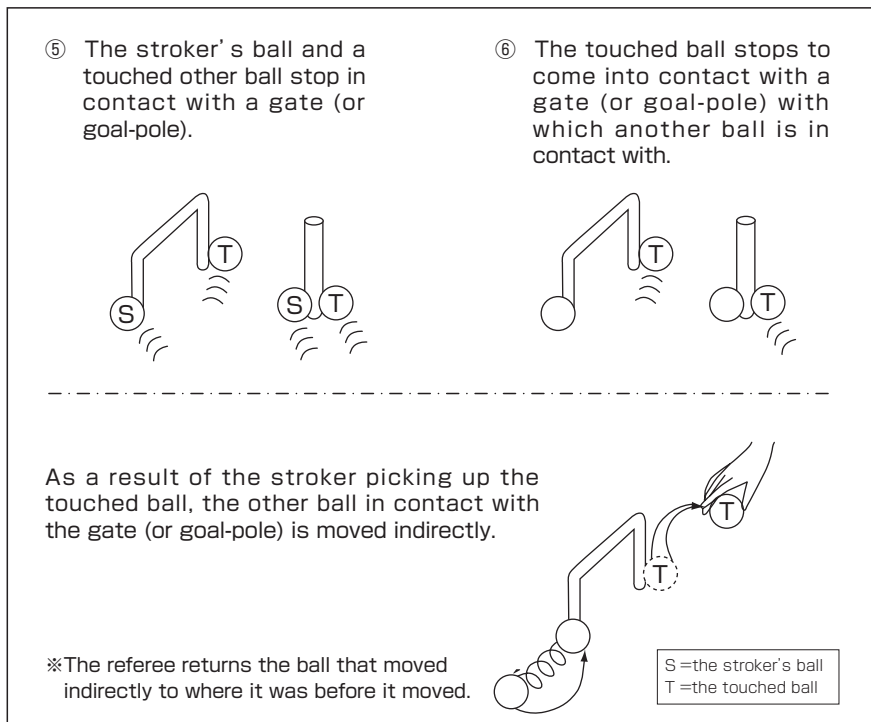

Figure 27 An invalid move caused indirectly by an action on Sparking (Example 2)

- 2) What to do when, after a successful Spark, a sparked ball comes into contact with the stroker's ball and then stops (Article 16, Clause 4.1.(6) and 4.2.(4) of the Rules)
 - ① If, after a successful Spark, the sparked ball hits a gate or goal-pole and rebounds, and the sparked ball and the stroker's ball are in contact with each other and both balls stop as in-balls, Referee A shall announce "Foul".
 - a. The sparked ball is placed where it stopped in contact with the stroker's ball after sparking.
 - b. The stroker's ball becomes an out-ball from where it stopped in contact with the sparked ball after sparking.

- 3) What to do when the stroker's ball moves from under the foot (Article 16, Clause 2.2.(6) of the Rules)
 - ① If the movement of the stroker's ball under the foot affects moves such as a pass through the gate, a finish or "agari", or a Touch, Referee A returns the stroker's ball to where it was before it moved.
- 4) If, after placing the sparked ball as an out-ball, Referee B has not moved to a position where he/she can make a decision on the movement of a ball as a result of continuous play (or a Spark), Referee A shall carry out the following:
 - ① Ask the stroker to wait before stroking (or sparking).
 - a. The time a stroker is asked to wait before stroking (or sparking) constitutes referee time.
 - ※ Any play during that time shall be seen as invalid. (Article 10, Clause 2 of the Rules)
 - ② Confirms that Referee B has moved, and then instructs the stroker to stroke (or spark) by saying "Proceed".

6. The Interaction Between the Chief Referee and Assistant Referee with Regards to Finished ("Agari") Balls.

- (1) Deciding on and announcing finished balls.
 - 1) Referee A decides on and announces a finished ball.
 - ① Depending on the situation, Referee B can make the decision and the announcement.
- (2) Dealing with the finished ball.
 - 1) Once a stroker's ball has finished, the chief referee and assistant referee carry out the following, depending on the situation.
 - ① The referee picks up the finished ball and hands it to the stroker whose turn has ended.
 - ② Notifies the stroker whose turn has finished to pick up the finished ball.
 - ③ After the ball has achieved an "agari", and the stroker gains the right for continuous play (or Spark), the referee can hold the finished ball and hand it to the stroker after his/her turn has ended.

- 2) If another ball moves as the result of a finished ball, the chief referee and the assistant referee return all the other balls that moved after the “agari” to where they were before they moved.

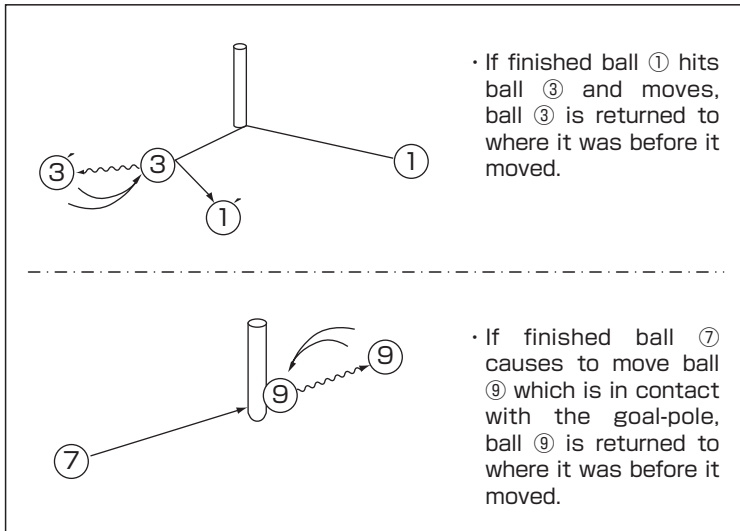

Figure 28 An invalid move by a ball that has finished (Example)

[V] The Recorder

1. Duties of the Recorder

- (1) Inspection of the ground
- (2) Entering the necessary information into the record sheet (Refer Figure 29)
- (3) Confirming and repeating the announcement of a successful pass through the gate or finish.
 - 1) Complying with announcements by the chief referee and assistant referee, repeating and confirming the announcement, and placing a tick by the score on the record sheet.
 - ① After the game has ended, adding up the points and handing the results to the chief referee and receive his/her confirmation.
- (4) Responding to any queries by the chief referee or assistant referee about the record sheet.
 - 1) Confirming the playing order and stokers
 - 2) Confirming the score
 - 3) Confirming player substitutions and advising the chief referee
 - 4) Confirming records related to the gate line
 - 5) Confirming absent players
- (5) Advising and assisting the chief referee and assistant referee in relation to their decisions, announcements, calls, and implementation of measures.
 - 1) A referee who realizes that a referee error has taken place must immediately advise and assist that referee
- (6) Confirming a player substitution and advising the chief referee
- (7) Counting game time
 - 1) Game time is measured from the moment the chief referee announces “Play Ball”.
 - 2) If the chief referee announces “Time” because of a game interruption, the recorder temporarily pauses counting game time.
 - 3) If the chief referee announces “Play” to resume the game, the recorder resumes counting the game time.
- (8) Announcing the progression of the game
 - 1) “15 minutes left”, “10 minutes left”, “5 minutes left”, and “Time up”

are each announced twice.

- ① The progression of the game should be announced loud enough to reach the entire court, and done so twice, facing one direction and then the other.
- (9) Deciding on, announcing, and implementing measures related to an out-ball.
- (10) Issuing a warning to those who are not observing the basic conditions to be observed by the manager and players

2. The Location of the Recorder (Refer Figure 3)

- (1) In principle, the recorder shall be positioned in the outer field.
 - 1) The position should be one in which the progression of the game, such as a successful pass through the gate, can be easily confirmed
 - 2) Depending on the situation, the recorder advises and assists the chief referee and assistant referee in the inner field.

3. Entering the Record Sheet (Example)

- (1) Details to be entered before the game:
 - 1) Competition name, venue name and date
 - 2) Court number and game number
 - ① Either 'game' or 'round' to be circled
 - 3) Name of the referee for that game
 - ① If a linesman is present, this is to be entered into the "Remarks" column
 - 4) The coin toss
 - ① Place a tick in the appropriate box to show if the team that won the right to choose to lead or follow by the coin toss chose to lead or follow.
 - 5) Details to be entered into the playing order sheet
 - ① Enter the team's name.
 - ② Enter the names of the players, the substitute players, and the manager.
 - ③ The captain's playing order number (or the substitute player) is circled.
- (2) Details to be entered once the game has started
 - 1) The time that the game started

- 2) The number of rounds
 - ① When the first player is called to stroke, the number of rounds is deleted with a tick.
- 3) The score
 - ① Once a successful pass through the gate and a successful finish (“agari”) is confirmed and the confirmation repeated, a tick is entered into the appropriate box.
- 4) Any information related to the gate-line is entered (Refer Figure 30)
- 5) Substitution of players
 - ① If there is a notification of a substitution, the substituting player is confirmed, and the playing order, and the number of substitution(s) is entered into the section on the appropriate substitute player as “○ (playing order) – ○ (the number of substitution(s))”
 - ② When the chief referee announces the substitution, draw a line in the appropriate score section.
- (3) Details to be entered after the game
 - 1) The time that the game ended
 - 2) The points earned for each playing order
 - 3) The overall score achieved by each team
 - ① The chief referee confirms the details in the record, and circles the winning team’s total score
 - 4) The captain’s signature
 - ① The captain confirms the details of the record, and then adds his/her signature.
- (4) Other details to be entered
 - 1) Tie-breaker
 - ① With the first round of the tie-breaker, the number of the player who achieved a successful pass through the first gate is deleted with a tick.
 - ② If the winner is not determined in the first round of the tie-breaker, the playing order to determine the winner is entered as “Round ○ , number ○”.
- 2) Remarks Column
 - ① The name of the linesman
 - ② The time that the game was interrupted and the reason (Example - 0 hours 0 minutes, interrupted due to thunder storm)

- a. The time that the game resumed following the interruption (Example - 0 hours 0 minutes, game resumed)
 - b. The reason why the game was postponed following the interruption (Example - Game postponed as the weather didn't improve.)
 - c. The reason for a called game after the interruption (Example - Called game as the weather didn't improve)
- ③ The time that the game was forfeited and why (Example - 0 hours 0 minutes, the team announced its intention to abandon the game)
 - ④ The time that a player became absent, his/her playing number, and the reason for the absence (Example - 0 hours 0 minutes, player number ○ absent due to injury)
 - ⑤ Others

記録表 / SCORE SHEET

競技名 Competition Name		15th WORLD GATEBALL CHAMPIONSHIP										コート番号 Court No.	開始時刻 Start
会場名 Ground		RAINBOW STADIUM										試合・回戦 Match No.	終了時刻 End
		年月日 Date										07	13
		September 18 - 19, 2030										02	13

先発チーム / Leading Team													後発チーム / Following Team																
H Family Club													GB Bears																
競技者名 PLAYERS NAME													競技者名 PLAYERS NAME																
No.	1	3	5	7	9	1	2	4	6	8	10	No.	2	4	6	8	10	得点 Points	3	2	1	5	5	得点 Points	3	2	1	5	5
選手 No.	①	3	5	7	9	1	2	4	6	8	10	選手 No.	2	4	6	8	10	TEAM POINTS	16	16	16	16	16	TEAM POINTS	16	16	16	16	16
監督 Manager	Bob Blair												監督 Manager	Jeff Bent															

主審 / Chief Referee	副審 / Assistant Referee	記録員 / Recorder	補記 / Remarks
Tomas Johnson	Rika Toyota	Bob Adams	LINESMAN / Amy Horris

Check off one number each time the first player (Ichi-ban) is called to stroke.

After the coin toss, place a tick in the box of the team that won the right to choose to lead or follow.

When a substitution is notified, confirm the substituting player and note his/her playing order and the number of substitution(s) for that playing order.

If a linesman is used, state so in the "Remarks" column.

Confirm the captain and indicate this with a 'C' around the playing order.

Draw a line when the chief referee announces the substitution.

Figure 29 Entering the record sheet (Example)

- (i) If a ball stops on the gate line, and the following applies, the recorder enters a small circle inside the box (upper left) in the score check column in the record sheet.
- When an in-ball moves from the back side so that it stops on the gate line of the gate that the ball is to pass through next.
 - When, as the result of stroking an out-ball, the ball stops on the gate line of the gate that the ball is to pass through next.
 - When, as the result of a foul after setting the balls following a Spark, the set ball is placed on the gate line of the gate that the ball is to pass through next.
- (ii) If the outer edge of the ball which has been entered into the record with a ○ then moves away from the gate line, a horizontal line is drawn through the ○ symbol. (⊕)

(Record Sheet)

	1G	2G	3G	上がり GP	得点 Points	1G
1	✓	⊕				2
3	✓	✓				
5	✓					
7	✓	○				
9						

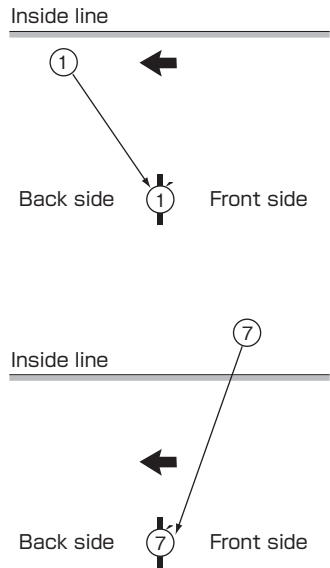

Figure 30 Record related to the gate line (Example)

[VI] Linesman

1. Duties of the Linesman

- (1) Inspection of the ground
- (2) Advising and assisting the chief referee and assistant referee in relation to their decisions, announcements, calls, and implementation of measures.
 - 1) A referee who realizes that a referee error has taken place immediately advises and assists that referee.
- (3) Deciding on, announcing and implementing measures related to out-balls
- (4) Issuing warnings to those who are not observing the basic conditions to be observed by the manager and players

2. The Location of the Linesman

- (1) In principle, the linesman is positioned in the outer field
 - 1) The position should be one in which the progression of the game can be easily confirmed.
 - 2) Depending on the situation, the linesman advises and assists the chief referee and assistant referee in the inner field.

(VII) The Referee's Announcements, Notifications and Hand Indications (Gestures)

1. Guide to the Referee's Announcements, Notifications and Hand Indications (Gestures)

- (1) Guide to the referee's announcements, notifications and hand indications (gestures)
 - 1) Decisions should be made quickly.
 - 2) Notifications and announcements as well as hand gestures should not be made while walking or running.
 - ① Hand gestures should be exaggerated and accurate.
 - a. Either hand can be used for hand gestures.
 - ② Announcements should be made in a loud voice.
 - a. In principle, when an announcement is made, the playing number of the corresponding player shall be announced first.

2. The Chief Referee's Announcements and Notifications

Situation	Start of the game (restart of the game)
Call	“Play Ball” (Play)

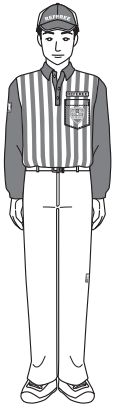

Initial stance

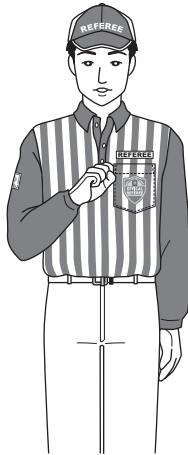

(i)



(ii)



- (i) From the initial stance, form a fist and raise it to the chest while bending the elbow.
- (ii) Open the fist and raise the hand to the front of the face.

Note

- The call is made together with the hand gesture.
- Gestures (i) and (ii) are carried out in a single move.
- The fingers should be close together.
- Call out “Play” to announce the start of the game, using the same gesture as “Play Ball”.

Situation	End of the game
Call	“Game Set”

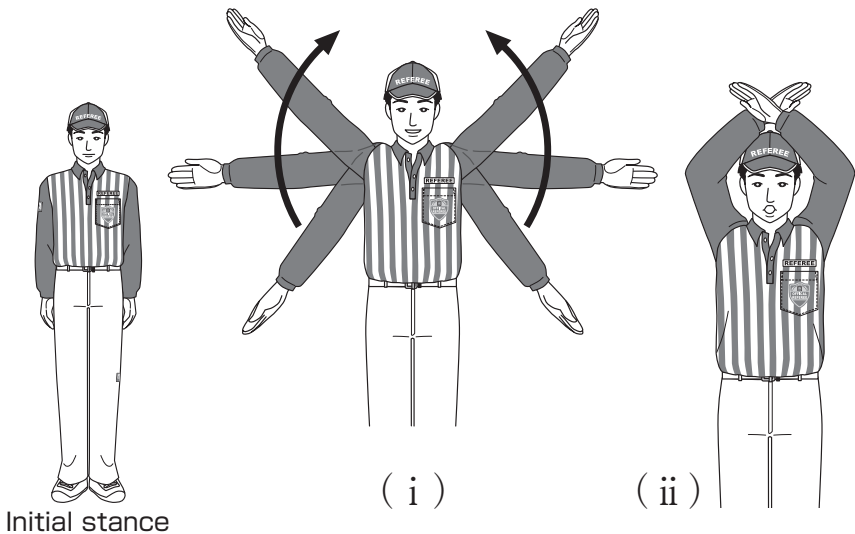

- (i) From the initial stance, open the palms of both hands, and stretching both arms, raise the hands as though drawing circles in the air on the left and on the right with the fingertips.
- (ii) When the arms are straight up above the head, bend the elbows and cross the arms at the wrists.

Note _____

- The call is made together with the hand gesture.
- Gestures (i) and (ii) are carried out in a single move.
- The fingers should be close together.

Notification to Stroke

Notification



·1st player
(ichi-ban)



·2nd player
(ni-ban)



·3rd player
(san-ban)



·4th player
(yon-ban)



·5th player
(go-ban)



·6th player
(roku-ban)



·7th player
(nana-ban)



·8th player
(hachi-ban)



·9th player
(kyuu-ban)



·10th player
(juu-ban)

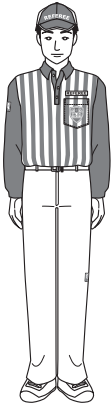

Initial stance

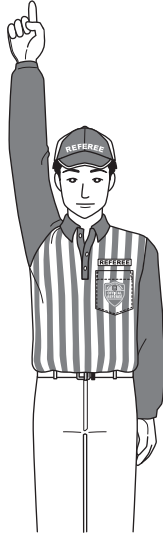

1st player~5th player



6th player~10th player

- (i) From the initial stance, use the fingers to indicate the playing order, and raise one hand (or both hands) to the front of the body while stretching the arm.
- (ii) Stretch the arms upwards so that both arms are vertical.

Note

- The call should be made together with the gesture.
- The fingers are spread out.

Approval	Player substitution
Call	“○ ban koutai”

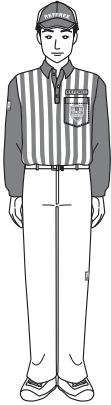

Initial stance

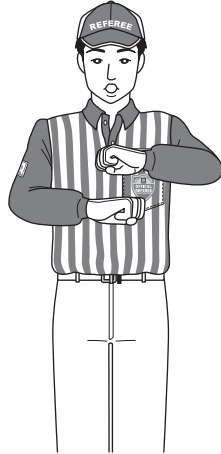

(i)

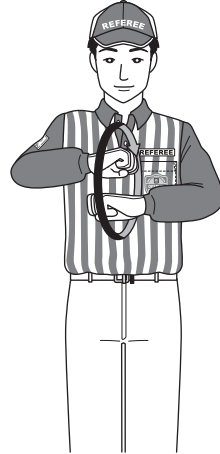

(ii)

(i) From the initial stance, make a fist with both hands and raise them to the chest with the back of the hands facing up and the elbows bent.

(ii) Rotate the fists around each other.

Note _____

- The call should be made together with the gesture.
- Gestures (i) and (ii) are carried out in a single move.
- Rotate both hands around each other two to three times.
- The hands can be rotated clockwise or anti-clockwise.

Situation	Interruption of the game
Call	“Time”

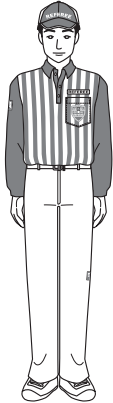

Initial stance



(i)



(ii)

- (i) From the initial stance, with the palm of one hand facing down, raise the hand to the chest while bending the elbow.
- (ii) Place the palm of the other hand so that it is perpendicular to the horizontal arm and touches the palm of the horizontal arm with the fingertips.

Note

- The call should be made together with the gesture.
- Gestures (i) and (ii) are carried out in a single move.
- The fingers should be close together.

3. Announcements by the Chief Referee and the Assistant Referee

Decision	Successful pass through the gate
Call	“○ ban ○ gate tsuka”

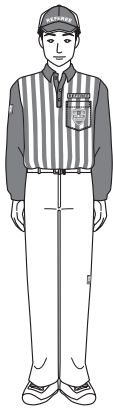

Initial stance

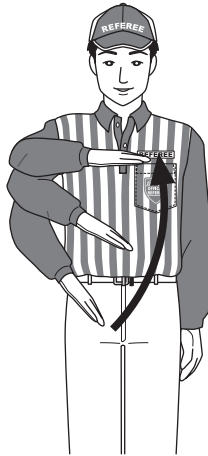

(i)

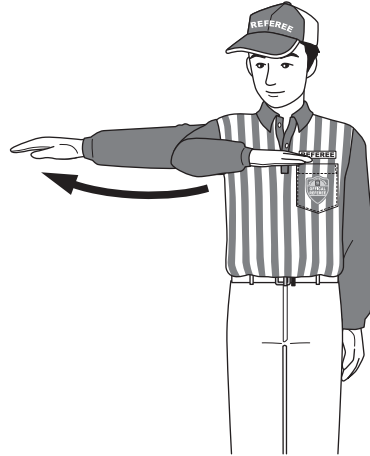

(ii)

- (i) From the initial stance, open one hand so that the back of the hand is facing up and, while bending the elbow, bring the arm horizontally to the chest.
- (ii) Move the raised palm horizontally in the direction of the pass.

Note _____

- The call should be made together with the hand gesture.
- Gestures (i) and (ii) are to be carried out in a single move.
- The fingers should be close together.

Decision	A successful “agari” (finished ball)
Call	“○-ban agari”

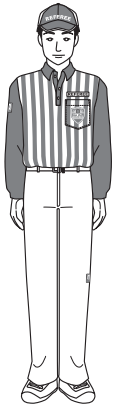

Initial stance

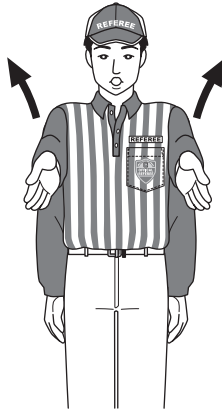

(i)



(ii)

- (i) From the initial stance, open both palms and raise them to the front of the body while stretching the arms.
- (ii) The arms are raised so that they form a V above the head.

Note

- The call should be made together with the gesture.
- Gestures (i) and (ii) are to be carried out in a single move.
- The fingers should be close together.
- The palms should be facing each other.
- If the number of the finished ball is unclear, the referee can announce “agari” , followed by “○ ban”

Decision	A successful Touch
Call	“○ ban ni Touch”

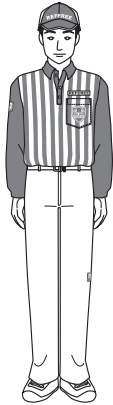

Initial stance

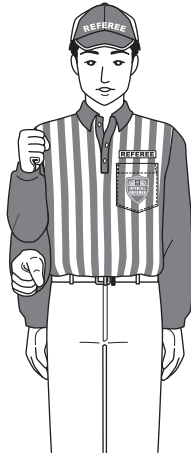

(i)



(ii)

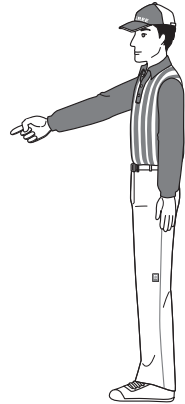

- (i) From the initial stance, form a fist, bend the elbow, and raise the fist to the shoulder.
- (ii) Stretch out the arm and use the index finger to point to where the Touch took place.

Note _____

- The call should be made together with the hand gesture.
- Gestures (i) and (ii) are to be carried out in a single move.
- Only one call is required even if several balls have been touched.
- If the number of the touched ball is unclear, the referee can announce “Touch” , followed by “○ ban”

Decision	Foul
Call	“Hansoku”

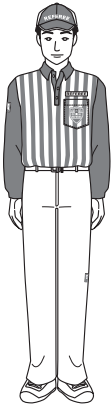

Initial stance

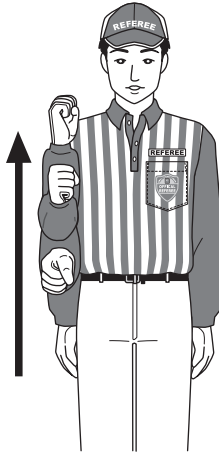

(i)

(i) From the initial stance, form a fist and raise it to the chin while bending the elbow.

Note

- The call should be made together with the gesture.
- The outer fist should point at the stroker who has committed the foul.
- The elbow should be held close to the body.

4. Announcements by the Chief Referee, the Assistant Referee, the Recorder and the Linesman

Decision	Out-ball
Call	“○ ban out-ball”



Initial stance



(i)

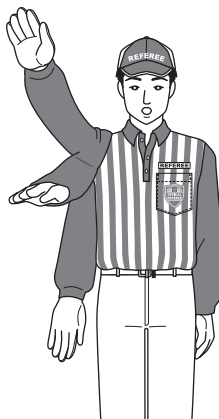

(ii)



(iii)

- (i) From the initial stance, the foot is used to stop the out-ball.
- (ii) One arm is raised to the front of the body while stretching the arm.
- (iii) The arm continues to be raised until it is pointing straight up.

Note

- The call is made together with the hand gesture.
- Gestures (i), (ii) and (iii) are to be carried out in a single move.
- The fingers should be close together.
- If the number of the out-ball is unclear, the referee can announce “Out-ball” , followed by “○ ban”
- The out-ball is dealt with after the announcement.

5. Supplementary Gestures

Decision

Safe

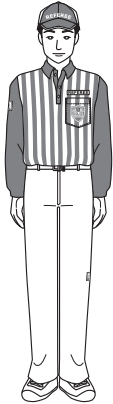

Initial stance



(i)

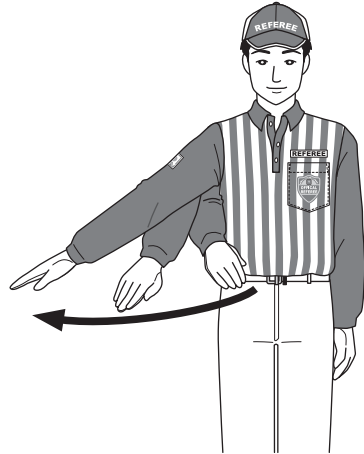

(ii)

- (i) From the initial stance, open one hand so that the palm is facing down, and place the arm in front of the body while bending the elbow.
- (ii) Open and stretch the same arm outward and put the palm diagonally in front.

Note

- The fingers should be close together.
- Gestures (i) and (ii) are carried out in a single move.

Situation

**Stroking or Sparking Standby
(permission)**

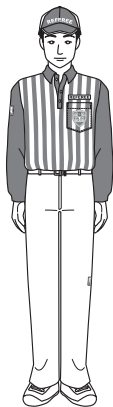

Initial stance

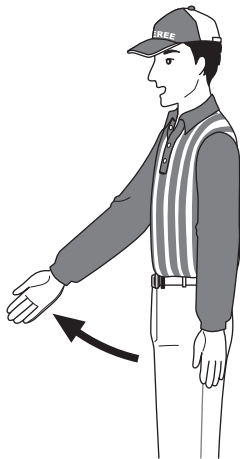

(i)

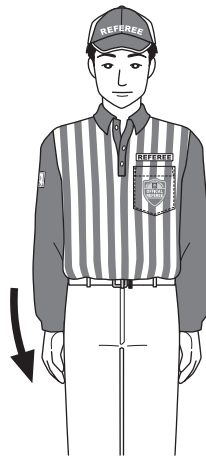

(ii)

- (i) From the initial stance, bring the arm out in front, pointing in the stroking direction, and get the player to standby for a stroke or Spark.
 - Ask the player to “Wait” so that h/she stands by for the stroke or Spark.
- (ii) Return to the initial stance, and approve the stroke or Spark.
 - Permit the player to stroke or Spark by saying “Proceed” .

Note

- The fingers should be close together.

6. Consecutive Calls

(1) Guide for consecutive calls

- 1) If two or more decisions or calls have to be made on a single stroke, the calls are made in the order of play.
 - ① When several calls are to be made, whoever is making the call returns to the initial stance each time before making a call.
 - ② If two or more decisions or calls occur at the same time or happen consecutively, the calls can be made consecutively.

(2) Multiple out-balls

- 1) If several balls become out-balls with intervals between one out-ball and the next, “__-ban out-ball”, “__-ban out-ball” are announced separately and in the order that the balls become out-balls.
- 2) If several balls become out-balls at the same time or one after the other, 1 “__-ban, __-ban out-ball” is announced.

(3) A ball that becomes an out-ball after passing through a gate

- 1) If there is an interval between a ball passing through the gate to it becoming an out-ball, “__-ban, __ gate tsuka” “__-ban out-ball” are announced separately.
- 2) If the ball becomes an out-ball immediately after passing through the gate, “__-ban, __ gate tsuka, __-ban out-ball” or “__-ban, __ gate tsuka, out-ball” is announced in succession.

(4) A ball that becomes an out-ball following a Touch

- 1) If there is an interval between a ball achieving a successful Touch and that ball becoming an out-ball, “__-ban ni Touch” is called, after which “__-ban out-ball” is announced.
- 2) If a ball becomes an out-ball immediately after a Touch, “__-ban ni Touch, __-ban out-ball” are announced in succession.

(5) A successful pass through the gate and a successful Touch

- 1) If there is an interval between a ball passing through the gate and that ball touching another ball, “__-ban, __ gate tsuka” and “__-ban ni Touch” are announced separately.
- 2) If there is an interval between a ball touching another ball to that ball passing through a gate, “__-ban ni Touch” and “__-ban, __ gate tsuka” are announced separately.
- 3) If a ball touches another ball immediately after passing through a gate, “__-ban __ gate tsuka, __-ban ni Touch” are announced in

succession to indicate a successful pass through the gate and a successful Touch.

- 4) If, after a successful Touch, the ball passes through a gate, “__-ban ni Touch, __-ban __ gate tsuka” are announced in succession to indicate a successful Touch and a successful pass through the gate.